

# CONDOR

---

**RATCHET DRIVE**  
CODE 511N

## OPERATOR'S MANUAL

*sc 20/6/96 ✓*

# ATTENTION



**THIS SYMBOL MEANS  
BE ALERT!**

**YOUR SAFETY IS INVOLVED**

**READ THIS MANUAL BEFORE USING THE CONDOR RATCHET DRIVE MOWER,  
IT IS ESSENTIAL THAT OPERATOR'S STUDY IT FOR THEIR OWN SAFETY.**

**ALL OPERATOR'S SHOULD SEEK AND OBTAIN PROFESSIONAL AND PRACTICAL  
INSTRUCTIONS ON THE SAFE USE OF THE MOWER.**

*sc 20/6/262*

CONTENTS	Page No.
<b>SAFETY PRECAUTIONS.</b>	<b>1.4 - 1.8</b>
Training.	1.4
Preparation.	1.4 - 1.5
Operation.	1.5 - 1.6
Maintenance and storage.	1.7
Decals.	1.8
<b>EC CONFORMITY INFORMATION.</b>	<b>1.9 - 1.11</b>
Noise levels.	1.9
Certificate of Conformity.	1.9
EC Declaration of Conformity.	1.10
EC Declaration of Incorporation.	1.11
<b>INTRODUCTION.</b>	<b>1.12</b>
<b>SPECIFICATIONS.</b>	<b>1.13 - 1.16</b>
Engine.	1.13
Transmission system.	1.14
Cutterhead drive system.	1.14
Power unit specifications.	1.14
Operator controls.	1.15
Weights and dimensions.	1.15
Recommended lubricants.	1.15
Rotary attachment	1.16
<b>ASSEMBLING THE MOWER</b>	<b>1.17 - 1.19</b>
Assembling the cutterhead attachment	1.17 - 1.19
Removing the cutterhead attachment	1.19

<b>CONTENTS</b>	<b>Continued.</b>	<b>Page No.</b>
<b>OPERATING THE MOWER.</b>		<b>1.20 - 1.26</b>
Operator presence control.		1.20
Control layout.		1.21
Braking system.		1.21
Throttle control.		1.21
Travel.		1.22
Cutterhead drive engagement.		1.22
Starting the engine.		1.23
Stopping the engine.		1.23
General operating hints.		1.24
Safe operation on slopes.		1.24 - 1.25
Adjusting height of cut.		1.26
Handlebar Height adjustment		1.26
<b>MAINTENANCE.</b>		<b>1.27 - 1.33</b>
Engine.		1.28
Running in period at first 50 hours.		1.28 - 1.29
Daily and before use.		1.29 - 1.30
Every 50 hours.		1.31
Every 200 hours.		1.31
General maintenance.		1.32
Rotary attachments.		1.33
Cutterblades.		1.33
<b>Preparing the mower for storage.</b>		<b>1.34</b>
<b>Grass cutting faults.</b>		<b>1.35</b>
<b>Trouble shooting.</b>		<b>1.36 - 1.37</b>
<b>Electrical circuit diagram.</b>		<b>1.38</b>
<b>Warranty.</b>		<b>1.39</b>

**SAFETY PRECAUTIONS**

**THIS SYMBOL MEANS BE ALERT! YOUR SAFETY IS INVOLVED. EXERCISE GREAT CARE AND FOLLOW THE ADVICE GIVEN TO AVOID POTENTIALLY HAZARDOUS SITUATIONS.**

**The Condor Ratchet Mower is perfectly safe if used correctly. Failure to observe the following simple precautions may result in serious injury. A careful operator who uses common sense is the safest operator.**

**TRAINING**



- Read the instructions carefully. Ensure that you are familiar with the controls and the proper use of the equipment. Learn how to stop the mower quickly in an emergency.
- Never allow children or people unfamiliar with these instructions to use the mower. Local regulations may restrict the age of the operator.
- Never mow while people, especially children, or pets are nearby.
- Keep in mind that the user is responsible for accidents or hazards occurring to other people or their property.

**PREPARATION**

















- While mowing, always wear substantial footwear and long trousers. Do not operate the equipment when barefoot or wearing open sandals.
- Thoroughly inspect the area where the mower is to be used and remove all objects which may be thrown by the machine.
- WARNING: Petrol is highly flammable.**
  - Store fuel in containers specifically designed for this purpose.
  - Refuel outdoors only and do not smoke while refuelling.
  - Add fuel before starting the engine. Never remove the cap from the fuel tank or add petrol while the engine is running or when the engine is hot.
  - If petrol is spilled, do not attempt to start the engine but move the mower away from the area of spillage. Avoid creating any source of ignition until petrol vapours have dissipated.
  - Replace fuel tank and container caps securely.
- Replace faulty silencers.

**PREPARATION** 

Continued.







-  Always ensure that the mower is in safe operating condition. Frequently check all nuts, bolts and screws for tightness. Use only genuine **Hayter** replacement parts.
-  Damaged cutterblades and loose fixing bolts are major hazards. Before use, visually inspect the cutting mechanisms to ensure that they are in good condition. Damaged cutterblades must be replaced immediately with genuine **Hayter** replacement parts. Unbalanced cutterblades may cause serious damage to your machine. Refer - MAINTENANCE.
-  On cutterheads with twin cutterheads, take care as rotating one bottom plate will cause the other to rotate.

**OPERATION** 

-  Do not operate the engine in a confined space where dangerous carbon monoxide fumes can collect.
-  Mow only in daylight or good artificial light.
-  Avoid using the mower on wet grass, where feasible.
-  Walk, never run.
-  Do not use on slopes of more than 20 degrees.
-  Always be sure of your footing on slopes and stay alert for humps, hollows and other hidden hazards.
-  Ground conditions may affect the ability of the operator to maintain safe footing . Particular conditions may not permit safe operation on the slope limit stated.
-  Mow across the face of slopes, never up and down.
-  Exercise extreme caution when changing direction on slopes.
-  Do not mow excessively steep slopes.
-  Always mow at slow speed on slopes.
-  Use extreme caution when reversing or pulling the mower towards you.
-  Disengage the cutterhead drive if the mower has to be tilted for transportation when crossing surfaces other than grass and when transporting the mower to and from the area to be mowed.
-  Never operate the mower unless the guards are securely in position in good condition and all safety devices are in place.
-  Do not change the engine governor settings or overspeed the engine. Operating an engine at excessive speed may increase the hazard of personal injury.
-  Disengage the cutterhead and ground drive clutches before starting the engine.

**OPERATION**

Continued.







-  Start the engine carefully, with feet well away from the cutting devices.
-  Do not tilt the mower when starting the engine.
-  Do not put hands or feet near or under rotating parts.
-  Move the throttle control lever to the 'stop' position, stop the engine, set the parking brake and disconnect the spark plug lead:
  - Before clearing blockages or unclogging the discharge.
  - Before cleaning / checking or working on the mower.
  - After striking a foreign object. Inspect the mower for damage and make repairs before restarting and operating the mower.
  - If the mower starts to vibrate abnormally ( check immediately ).
-  Move the throttle control lever to the 'stop' position, stop the engine and set the parking brake:
  - Whenever you leave the mower.
  - Before making height of cut adjustments.
  - Before refuelling.
-  Reduce the throttle setting during engine shut down.



**WARNING: THE CUTTING DEVICES CAN CONTINUE TO ROTATE AFTER THE ENGINE IS SWITCHED OFF.**

se 20/06/06

**MAINTENANCE AND STORAGE** 

-  Keep all nuts, bolts and screws tight to ensure that the equipment is in safe operating condition.
-  Never store the mower with petrol in the tank within an enclosed area where fumes may reach an open flame or spark.
-  Allow the engine to cool before storing in any enclosure.
-  To reduce the fire hazard, keep the engine, silencer and petrol storage area free of grass, leaves or excessive grease.
-  Be careful during adjustment to prevent entrapment of the fingers between moving cutting devices and fixed parts of the machine. On twin bladed cutterheads, take care as rotating one bottom plate will cause the other to rotate.
-  Replace worn or damaged parts for safety.
-  If the fuel tank has to be drained, it is essential that this is done outdoors.

**Health and Safety at Work Act:**

In accordance with section 6 of the Health and Safety at Work Act 1974, the Condor Ratchet Mower and attachments have been designed and constructed so that, in so far as is reasonably practical, they will not endanger the safety and health of those working with them. This is, however, subject to the machine and attachments being properly used and maintained according to the conditions stated in this manual and elsewhere, which have been found necessary as the result of the research and testing of Hayter Limited.



**DECALS**

**Decal - Control Panel.**

Location: Control Panel.

Part No. 511112.

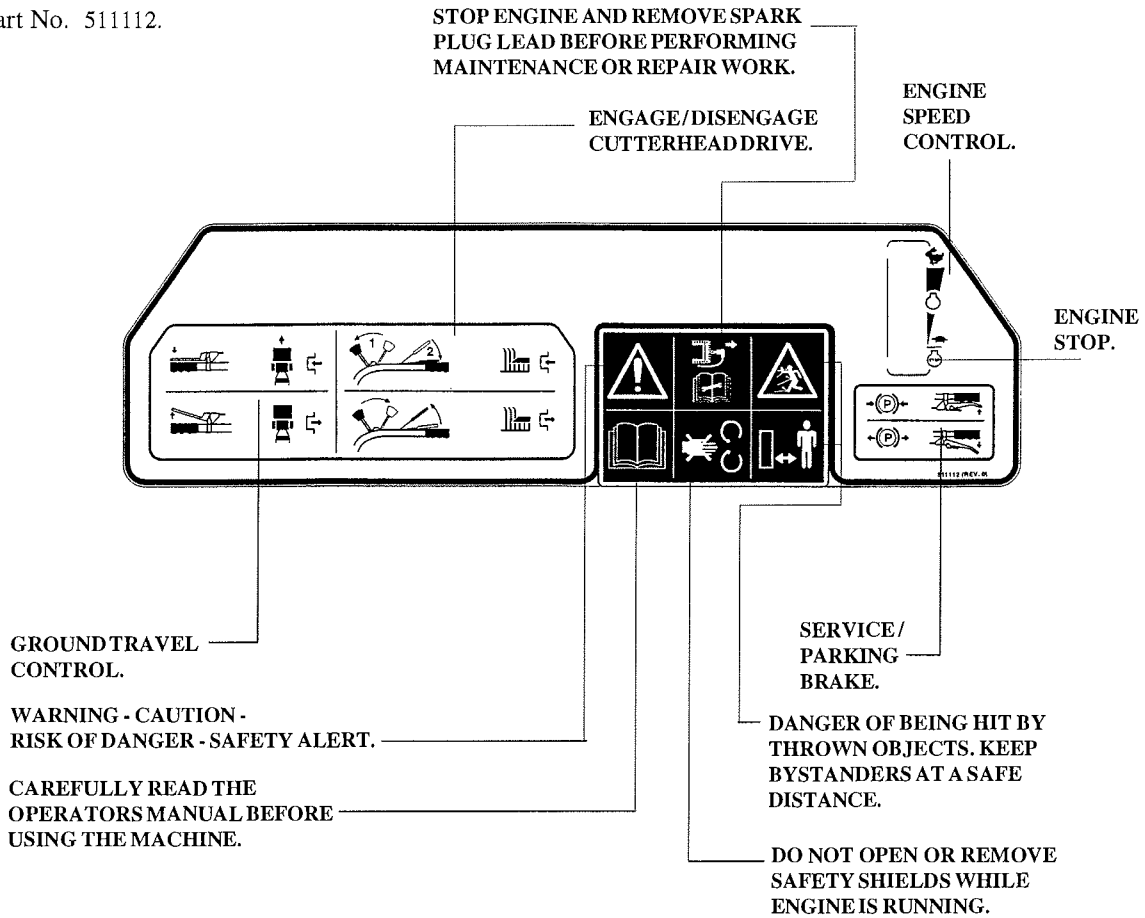

**Decal - Severing of hand or fingers.**

Location: Right and left hand side of cutting deck.

Part No. 40-13-010



**Decal - Cut Height Adjustment:**

Location: Cutter Deck.

Part No. 320006

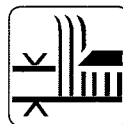

**Decal - Cutterhead Timing**

Location: Between gearboxes on rotary attachment.

Part No.5905

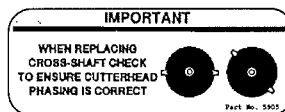

**Decal - Gears**

Location: Gear lever gate

Part No: 511113

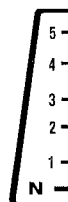

*se 20/6/06c*

### NOISE LEVELS

**Operators Daily Personal Noise Exposure:** HAYTER LIMITED have no control over site conditions, duration of use, state of maintenance or adjustment of the mower. All of these factors will affect the operator's daily personal noise exposure level -  $L_{EP,d}$

Under typical working conditions operators could be exposed to a daily personal noise exposure level in excess of 85 dB (A)  $L_{EP,d}$

**Sound pressure level:**

The maximum sound pressure level at the operator's position is 87dB(A) under typical working conditions.

**Sound power level:**

The maximum sound power level is 100 dB(A) under typical working conditions.

If ear protection is required, ear protectors with good attenuation in the 63- 8000 Hz frequency range should be used.

Employers of personnel using this machine are advised to read the 'Noise at Work Regulations' as the operator's daily personal exposure level could be above the 'First Action Level'.

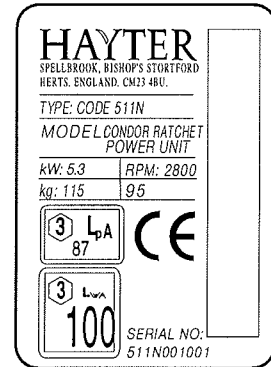

### CERTIFICATE OF CONFORMITY

#### CERTIFICATE OF CONFORMITY

I, the undersigned **A.D.Bone**, of:  
HAYTER LIMITED, Spellbrook, Bishop's Stortford, Herts, CM23 4BU, ENGLAND.  
certify that the lawnmower;

- |                                  |                   |
|----------------------------------|-------------------|
| 1. Category.                     | Combustion Engine |
| 2. Make.                         | Hayter            |
| 3. Type.                         | 511N              |
| 4. Identification of the series. | Condor            |
| 5. Engine - Manufacturer.        | Kohler            |
| - Type.                          | Magnum M8         |

conforms to the specifications of Directive 84/538/EEC as adapted to technical progress by Directive 87/252/EEC and amended by Directive 88/180 /EEC.and Directive 88/181/EEC

Maximum sound power level guaranteed 100 dB(A).

Maximum sound pressure level at the operator's position guaranteed 87 dB(A).

- |  |          |
|--|----------|
| - Type   | 212N     |
| - Type of cutting device.                          | Rotary   |
| - Width of cut.                                    | 76.2 cm  |
| - Speed of rotation of engine during test.         | 2800 rpm |
| - Speed of rotation of cutting device during test. | 2700 rpm |

TESTED AT SADBURY, SUFFOLK, ENGLAND.

Signed:   
A.D.Bone  
(Technical Manager).

Date: 12/03/96

## EC DECLARATION OF CONFORMITY

## DECLARATION OF CONFORMITY

Company Name  
Company Address

HAYTER LIMITED.  
Spellbrook  
Bishop's Stortford  
Herts. CM23 4BU  
ENGLAND



Machine Code No.  
Model.

511N  
Condor - Ratchet Drive Power Unit

Directives complied with: 89/392/EEC amended by 91/368/EEC, 93/44/EEC and 93/68/EEC.  
Essential Health and Safety Requirements Relating to the Design and Construction of  
Machinery and Safety Components.  
84/538/EEC amended by 87/252/EEC, 88/180/EEC and 88/181/EEC Permissible Sound Power Levels of Lawn Mowers.  
89/336/EEC amended by 92/31/EEC Electromagnetic Compatibility.

SI 1962 No. 1472 Agricultural Employment Safety, Health and Welfare. The Agriculture (Field Machinery) Regulations 1962.

Standards Used: BSEN 292, ISO 5395, EN50081, EN50082.

I declare on behalf of HAYTER LIMITED that this machine conforms to the EC Essential Health and Safety Requirements.

Signed:  Date: 27.3.96  
A.D. Bone  
( Technical Manager ).

Lawnmower vibration information. RMS acceleration measured in 3 - axes at operators contact position on the handlebars =  $15.5 \text{ ms}^{-2}$

sc 20/6/96

### EC DECLARATION OF INCORPORATION

#### EC DECLARATION OF INCORPORATION

Company Name HAYTER LIMITED.  
 Company Address Spellbrook  
 Bishop's Stortford  
 Herts. CM23 4BU  
 ENGLAND

Machine Code No. 212N  
 Models 30" Rotary Attachment

Directives complied with: 89/392/EEC amended by 91/368/EEC, 93/44/EEC and 93/68/EEC.  
 Essential Health and Safety Requirements Relating to the Design and Construction of  
 Machinery and Safety Components.  
 84/538/EEC amended by 87/252/EEC, 88/180/EEC and 88/181/EEC Permissible Sound Power Levels of Lawn Mowers.

SI 1962 No. 1472 Agricultural Employment Safety, Health and Welfare. The Agriculture (Field Machinery) Regulations 1962.

Standards Used: BSEN 292, ISO 5395.

These attachments must only be used in conjunction with Code 511N or Condor Power Unit which have been declared in conformity with Directive 89/392/EEC amended by 91/368/EEC, 93/44/EEC and 93/68/EEC.

I declare on behalf of HAYTER LIMITED that this attachment conforms to the EC Essential Health and Safety Requirements.

Signed:  Date: 27.3.96  
 A.D. Bone  
 ( Technical Manager ).

**! WARNING:** Under no circumstances can attachments other than those covered by the above EC Declaration of Incorporation or other attachments that may be introduced by Hayter Limited in the future, having a similar EC Declaration of Incorporation, be supplied for or fitted to the Code 511N Condor Ratchet Drive Power Unit. Unauthorised use of other equipment will invalidate the EC Declaration of Conformity and may cause the mower to be unsafe. The fitting of genuine 'Hayter' attachments which fall outside the definition of 'machinery' is permitted and is the only exception to this rule.

**INTRODUCTION**

The Condor Ratchet Mower is a total grass cutting system designed for professional use. Optional attachments are available which can be quickly interchanged.

The unit is petrol engine powered and has separate clutch controls for engaging the cutterhead and ground drives. The Condor Mower is well balanced and incorporates a number of features for effortless safe mowing. The handlebar controls are 'user friendly' and incorporate an operator presence control system. This system will automatically disengage the cutterhead and ground drive clutches when the operator releases the controls.

The Condor Ratchet Mower is a precision built machine designed for robust use, a high standard of finish and long life. The way in which this mower is operated and maintained will have a profound effect on its performance and reliability.

This manual contains advice on the safe operation of the Condor Ratchet Mower, which is offered for the guidance and protection of all those operating and servicing this machine.

In the pursuit of continuous product development, Hayter Limited reserve the right to alter specifications without notice.

---

**Cutterhead Variants:** The Condor Ratchet Mower can be fitted with the following cutterhead configurations:

**30" Rotary Attachment CODE 212N**

---

**Optional Extra:**

**Snow Blade Code 092**

---

**Left and Right:** Throughout this manual the terms 'Left' and 'Right' refer to the mower when looking in the direction of forward travel.

**SPECIFICATIONS**

ALL FIGURES ARE NOMINALLY QUOTED AT THE RATED ENGINE SPEED OF 2800 RPM UNLESS OTHERWISE STATED.

**ENGINE**

<b>Type:</b>	KOHLER MAGNUM 4 - Stroke, overhead valve, 1 cylinder
<b>Power Rating:</b>	7.0 hp (5.3 kW) @ 2800 RPM
<b>Capacity:</b>	305cc.
<b>Air Cleaner:</b>	High density paper element with oiled foam precleaner.
<b>Cooling System:</b>	Forced air.
<b>Oil type:</b>	SAE 30.
<b>Oil sump capacity:</b>	0.95 Litres ( 1.67 Imp. pints ).
<b>Fuel Type:</b>	Unleaded petrol - standard grade.
<b>Fuel capacity:</b>	4.75 Litres ( 1.04 Imp. gals ).

**IMPORTANT: PREVENT DAMAGE - for further information regarding the engine, refer to - ENGINE MANUAL .**

**TRANSMISSION SYSTEM**

**Primary drive:** Twin V - belt into 3 - way bevel Gearbox.

**Intermediate drive:** Single clutched V - belt drive.

**Final drive :** Chain drive via 5 speed gearbox.

**CUTTERHEAD DRIVE SYSTEMS**

**Power unit primary drive:** Twin V - belt into 3 - way bevel gearbox.

**Power unit final drive:** Twin clutched V - belt drive with integral engine lock - out switch sensor.

**Rotary attachments:** Swinging cutterblades attached to circular bottom plates on coupled gearboxes with pulley brake.

**POWER UNIT SPECIFICATIONS**

<b>Ground Speed:</b>	<b>1st gear</b>	1.6 km/hr. (1.0 m.p.h.)
	<b>2</b>	2.6 km/hr. (1.6 m.p.h.)
	<b>3</b>	4.0 km/hr. (2.5 m.p.h.)
	<b>4</b>	5.0 km/hr. (3.0 m.p.h.)
	<b>5</b>	6.0 km/hr. (3.7 m.p.h.)
		No Reverse.

Tyres	Tyre Type	Recommended max. Tyre Pressures
Standard	4.00 X 8 - 4 Ply Power Trac	2.2 bar (32 psi )

**Parking brake:** Lever operated drum brake.

**Safety features:** Neutral start interlock.  
Operator presence control.  
Braked cutterhead drive.

**OPERATOR CONTROLS**

<b>Cutterhead Drive:</b>	Hand operated lever to engage; maintained by single hand-operated OPC control.
<b>Engine Speed:</b>	Hand operated lever.
<b>Parking Brake:</b>	Hand operated lever with engagement lock..
<b>Forward:</b>	Hand operated lever/ Hand operated gear shift.

**WEIGHT AND DIMENSIONS**

<b>Maximum Working Width:</b>	860 mm. (34") - 30" Rotary attachment fitted.
<b>Maximum Mowing Width:</b>	762 mm. (30") - 30" Rotary attachment fitted.
<b>Maximum Overall Length:</b>	2050 mm. (81") - 30" Rotary attachment fitted.
<b>Overall Height:</b>	1060 mm. (42")
<b>Approx. Working Weight:</b>	190kg (419 lbs ) - 30" Rotary attachment fitted.

**RECOMMENDED LUBRICANTS**

**Grease points:** A good quality medium grease.

**Cutterhead gearbox ( Rotary Attachment ): SAE 90.**

**Engine:** SAE 30.

**3 - way bevel box:** SAE 90

**Five speed gearbox:** Shell Darina 2 or R2 grease.

Should you be in any doubt please contact your Hayter dealer. Using incorrect grades will cause premature wear and invalidate warranty.



**ROTARY ATTACHMENTS****Code 212N**

<b>Drive:</b>	V - Belt / Gearbox
<b>Cutting width:</b>	762mm ( 30" ).
<b>Type of blade:</b>	2 discs with swinging blades.
<b>No. of blades:</b>	4 (2 on each disc).
<b>Cutterbar speed:</b>	2700 r.p.m.
<b>Height of cut:</b>	20 - 55mm ( 3/4" - 2 1/8" ).

sc 20/6/86 ←

**ASSEMBLING THE CUTTERHEAD ATTACHMENT****Introduction:**

The Condor Ratchet Drive Power Unit Code 511N is designed to be used with the 30" Rotary Cutterhead Attachment Code 212N. This attachment can be quickly mounted to or removed from the Power unit.

**⚠ WARNING: PREVENT ACCIDENTS - Stop the engine, apply the parking brake and disconnect the spark plug lead before attempting to remove or mount a cutterhead attachment.**

**⚠ WARNING: PREVENT ACCIDENTS - Do not attempt to carry out the following procedure by yourself, another person must assist you.**

Power unit with rotary cutterhead attachment.

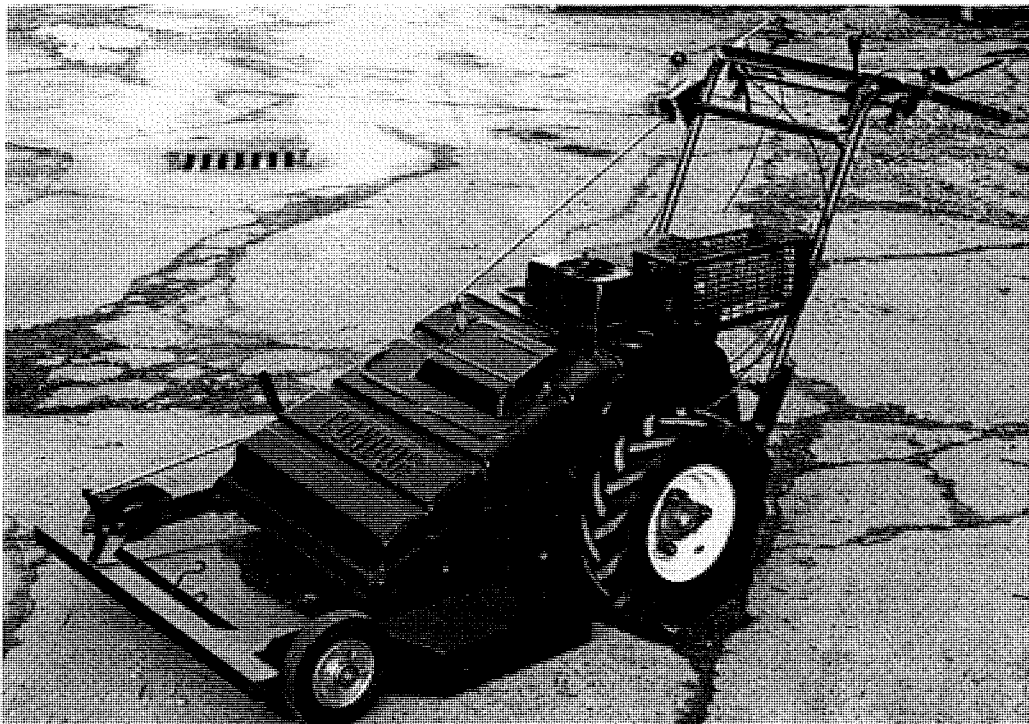

see 20/6/96 ←

### ASSEMBLING THE CUTTERHEAD ATTACHMENT

Continued

#### To assemble the cutterhead attachment to the power unit:

1. Position the cutterhead attachment on level ground.
2. Remove the cutterhead drive cover.
3. Remove the chain coupling from between the gearboxes on the Rotary Attachment.
4. Remove the drive belts from the rotary attachment and discard.
5. Loosen the lock nuts ( 1 ) and screw the two tensioning bolts ( 2 ) fully forward to provide maximum clearance for assembly.
6. Position the cutterhead attachment close to the front of the power unit.
7. One person should tilt the power unit down at the front by holding and raising the handles, whilst another person assembles the twin drive belts between the cutterhead pulley and the power unit countershaft pulley.
8. Align the power unit to the cutterhead mountings and connect up using the two mounting bolts, washers and nyloc nuts ( 3, 4 and 5). Do not fully tighten the bolts at this stage.

**Note:** The rotary attachment has two mounting holes. Assemble using the left hand holes (holes A).

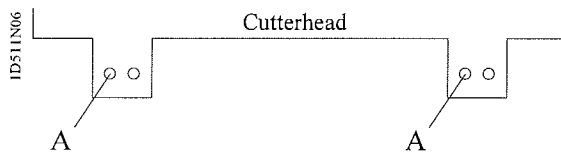

9. Refit the chain couplings, ensuring that the cutterhead timing is correct.
10. Adjust the two tensioning bolts ( fig. 1. items 2) equally to tension the twin drive belts. The bolts are correctly tensioned when a deflection of 50mm (2") is achieved using finger pressure as shown with the clutch disengaged, refer - fig 2.
11. Tighten the locknuts ( 1 ) and nuts ( 5), refer - fig. 1.
12. Re-check the belt tensions as previously described and readjust if necessary. The twin drive belts are matched but it is quite normal for there to be slight differences in tension between them.
13. Fit the belt guide, supplied with the ratchet power unit onto the rotary attachment, refer -fig 3. Adjust the belt guide ( 1) to obtain 1.5mm clearance between the under side of the guide and the belts when the drive clutch is engaged.

Fig. 1.

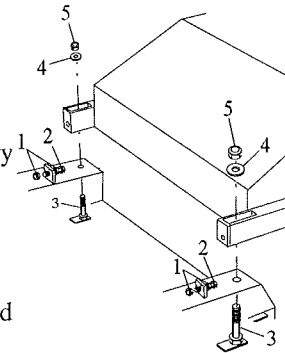

1. Nut.
2. Tensioning Bolt.
3. Mounting Bolt.
4. Washer.
5. Nyloc Nut.

Fig. 2

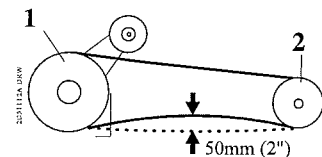

1. Countershaft pulley ( Power unit ).
2. Drive pulley attachment ( Cutterhead ).

Fig. 3

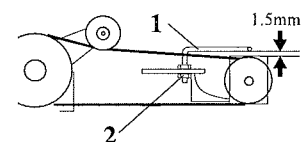

1. Belt Guide
2. Securing Nuts

**ASSEMBLING THE CUTTERHEAD ATTACHMENT**

Continued

13. Connect the inner cutter brake cable (1) to the cutter clutch lever (2) on the power unit, routing the cable between the gearboxes, around the right hand side of the engine and up the left hand handlebar. Slot the outer cable into the bracket (3) on the left hand handlebar. Adjust the cable adjuster to achieve the correct free play, refer - MAINTENANCE.

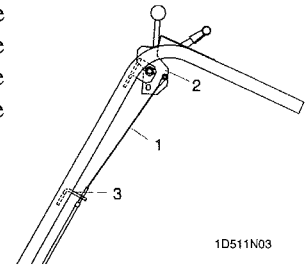

1. Inner Brake Cable.  
2. Cutter Clutch Lever.  
3. Cable Bracket.

14. Fit the cover securing plate (1), supplied with the ratchet power unit to the cover support with the screw uppermost and the plate pointing to the rear of the machine. Secure the plate using M8 nut and washer supplied.

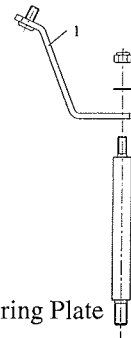

1. Securing Plate

15. Refit the cover to the cutterhead.

**! WARNING: PREVENT ACCIDENTS - Never operate the mower with the cover removed.**

**REMOVING THE CUTTERHEAD ATTACHMENT**

**To remove the cutterhead attachment from the power unit:**

This is achieved by adopting the procedure 'To assemble the cutterhead attachment to the power unit' in reverse order.

**SAFETY NOTICE**

**WARNING: PREVENT ACCIDENTS - Before operating the mower it is essential that;**

- The operator reads and understands this manual.
- The daily maintenance checks have been properly carried out and the mower is in good working order.
- The operator should wear safety clothing and eye protection. Failure to do so could result in damage and risk to health and safety.

**OPERATOR PRESENCE CONTROLS**

The controls incorporate operator presence controls ( OPC ) which provide for the protection, safety and health of the operator. This system has been designed to ensure that the cutterhead drive and ground drive clutches are automatically disengaged in the event of the operator releasing hold of the handlebars for whatever reason.

**Cutterhead drive:** The cutter clutch OPC lever is lightly spring loaded and is held down by the palm of the hand during operation. Release of the OPC lever will cause the cutterhead clutch to disengage whilst activating the brake to arrest the rotation of the cutting devices.

**Travel:** The machine drive clutch lever is spring loaded and will return to the disengaged position when released .

**Engine start lockout:** The engine can only be started when the cutterhead and ground drive controls are deactivated. The integral switch sensors will not allow the engine to be started unless this condition is satisfied.

**Engaging the cutter clutch OPC lever:** The cutterhead OPC lever should only be operated after engaging the cutterhead clutch control lever.



**WARNING: PREVENT ACCIDENTS - Do not operate the mower if the operator presence controls are defective in any way. ALWAYS replace faulty parts and check that they function correctly before operating the mower.**

se 20/6/20

## CONTROL LAYOUT

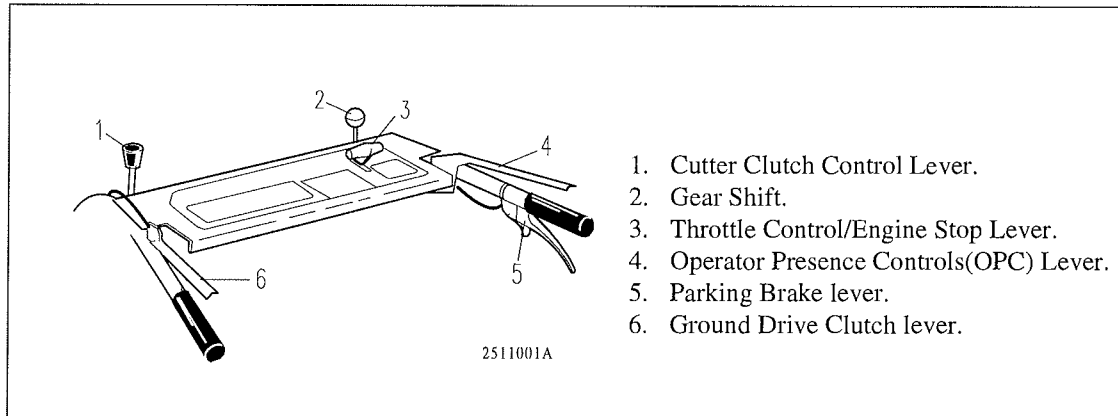

1. Cutter Clutch Control Lever.
2. Gear Shift.
3. Throttle Control/Engine Stop Lever.
4. Operator Presence Controls(OPC) Lever.
5. Parking Brake lever.
6. Ground Drive Clutch lever.

## BRAKING SYSTEM

**Parking brake:** The parking brake is operated by the right hand lever on the underside of the handlebar. To operate the parking brake, depress the lever until the spring loaded locking catch automatically engages. Release the brake lever and the parking brake is engaged. To take the parking brake off, depress the lever until the locking catch becomes free and move it out of engagement with the thumb. Release the brake lever and the parking brake is now disengaged.



**Service brakes:** Service braking is achieved by depressing the parking brake lever, without allowing the spring loaded catch to engage. Service braking is used to reduce the travel speed.

**WARNING: PREVENT ACCIDENTS-** The service braking system will not hold the mower at a standstill. ALWAYS ensure the parking brake is engaged to park the mower at a standstill.

## THROTTLE CONTROL

Operate the throttle control forwards to increase the engine speed.

Operate the throttle control backwards to reduce engine speed.

Operate the throttle control fully backwards to the detented position to stop the engine.

Note that the engine speed dictates the speed of the other functions, i.e. travel, cutterhead.



**TRAVEL**

**Forward travel:** Move the gear shift (1) forwards to the required speed setting (refer SPECIFICATIONS). Bear down on the ground drive clutch lever (2) with the palm of the hand to travel in a forward direction.

**Stop travel:** Release the ground drive clutch lever to stop travel. Move the gear shift lever to the neutral (N) position

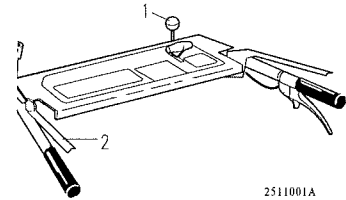

2511001A

1. Gear Shift
2. Ground Drive Clutch Lever.

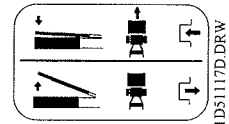
**CUTTERHEAD DRIVE ENGAGEMENT**

The cutterhead drive engagement mechanism is protected by the Operator Presence Control ( OPC ) system.

**To engage cutterhead drive:** Operate the throttle control to provide a suitable engine speed and push forward on the cutter clutch control lever to start the cutterhead. Maintain the cutter clutch control lever in the engaged position with the left hand while pushing downwards on the OPC lever with the palm of the right hand. Release the cutter clutch control lever and the cutterhead drive will remain engaged until such time as the OPC lever is released.

**To disengage cutterhead drive:** Release the cutter clutch (OPC) lever. Observe that the cutter clutch lever automatically returns backwards to the disengaged position.

**! WARNING: PREVENT ACCIDENTS - Do not operate the mower if the handlebar control or the operator presence control system is defective in any way. ALWAYS replace faulty parts and check that they function correctly before operating the mower.**

se 20/6/96

## STARTING THE ENGINE

This machine is fitted with an Engine Start Lockout, refer - OPERATOR PRESENCE CONTROL.

 **WARNING: PREVENT ACCIDENTS** - Before starting the engine check that ;

- The area is clear of bystanders.
- The cutterhead drive is disengaged.
- The parking brake is engaged.
- The ground drive clutch is disengaged.
- The gear shift lever is in the neutral (N) position .
- You have read and understood the Safety Precautions Section in this manual.

**IMPORTANT: PREVENT DAMAGE** - Before attempting to start the engine, ensure that the crankcase oil level is correct and check the fuel level.

**Starting a cold engine:** Set the throttle control lever ( on the mower front panel ) to approximately 70% full throttle and lift the choke lever ( on the engine ) to the full choke position.

Pull the start grip with a steady motion to start the engine.

Gradually return the choke lever to the open position as the engine warms up.

Once the engine has warmed up increase the throttle setting as required for operation.

**CAUTION: PREVENT DAMAGE** - Do not allow the start grip to snap back against the engine. Return it gently to prevent damage.

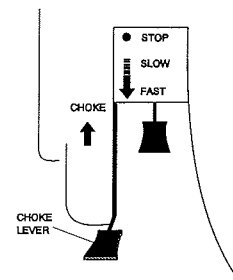

**Starting a warm engine:** The use of the choke will not normally be required when starting a warm engine.

## STOPPING THE ENGINE

**To stop the engine:** Stop the engine by moving the throttle control to the 'stop' position. In normal use bring the mower travel to a stop and disengage the cutterhead drive and engage the parking brake before stopping the engine.

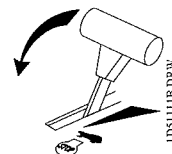

 **WARNING: PREVENT ACCIDENTS** - If the engine fails to stop when the throttle control lever is moved to the 'stop' position, lift the engine mounted throttle lever to the 'stop' position or disconnect the spark plug lead.



**GENERAL OPERATING HINTS**

1. The rotational speed of the cutterhead should always be kept as high as possible to maintain the highest quality of cut. This in turn requires the mower engine speed to be kept as high as possible.
2. The quality of cut will deteriorate if the forward speed is too high. Always balance the quality of cut with the workrate required and set the forward speed accordingly.
3. **Rotary attachment.** Ensure that the cutterblades and bottom plates are maintained in good condition.
4. **Always disengage the cutterhead drive when transporting across ungrassed areas.**
5. Cutting performance is best when cutting against the lie of the grass. In order to take advantage of this fact the operator should attempt to alternate the direction of mowing between cuts.

**SAFE OPERATION ON SLOPES**

**WARNING: PREVENT ACCIDENTS - Operation on slopes can be dangerous. Ensure that you have read and fully understood the safety precautions concerning operation on slopes which may be found at the beginning of this manual.**

The following techniques should be used when mowing banks or sloping ground:

1. Walk the ground to be worked on prior to mowing and remove all objects which may be thrown by the mower. Take note of all ground irregularities that may lead to loss of control of the machine or loss of footing. Make careful note of these areas and ensure that they are avoided during mowing. Do not attempt to mow sloping areas where the degree of such ground irregularities is excessive.
2. Assess the slope angle and ensure that it is within the limits stated in the safety precautions listed at the front of this manual.
3. Take note of the ground conditions and ensure that they are suitable for maintaining safe footing while operating the mower. Avoid mowing areas where the ground is slippery. It is recommended that footwear having soles with a high degree of grip are worn while mowing.

**SAFE OPERATION ON SLOPES**

Continued.

4. Start the engine, engage first gear and ensure that the cutterhead remains disengaged. Approach the top of the bank or sloping ground by travelling diagonally upwards across the face of the slope at the shallowest slope angle possible.
5. On reaching the top of the slope align the mower along the top of the bank, re-engage first gear and the cutterhead drive and proceed to mow along the top of the bank. Always use first gear when mowing banks or slopes.
6. When reaching the end of the cut path, disengage the cutterhead and ground drive clutches and apply the brake. Feather the brake control and pivot the machine about the ground drive wheel through 180 degrees in a reverse direction until aligned for the next cut. Take great care when carrying out this manoeuvre and use the brake to control the motion of the machine. Always attempt to make turning manoeuvres where the slope angle is at a minimum.
7. Continue by mowing across the face of the slope, turning at the ends as previously described and gradually work down the slope in a similar manner.



**WARNING: PREVENT ACCIDENTS - Always mow across the face of slopes, never up and down.**



**WARNING: PREVENT ACCIDENTS - Take extreme care when carrying out turning manoeuvres.**

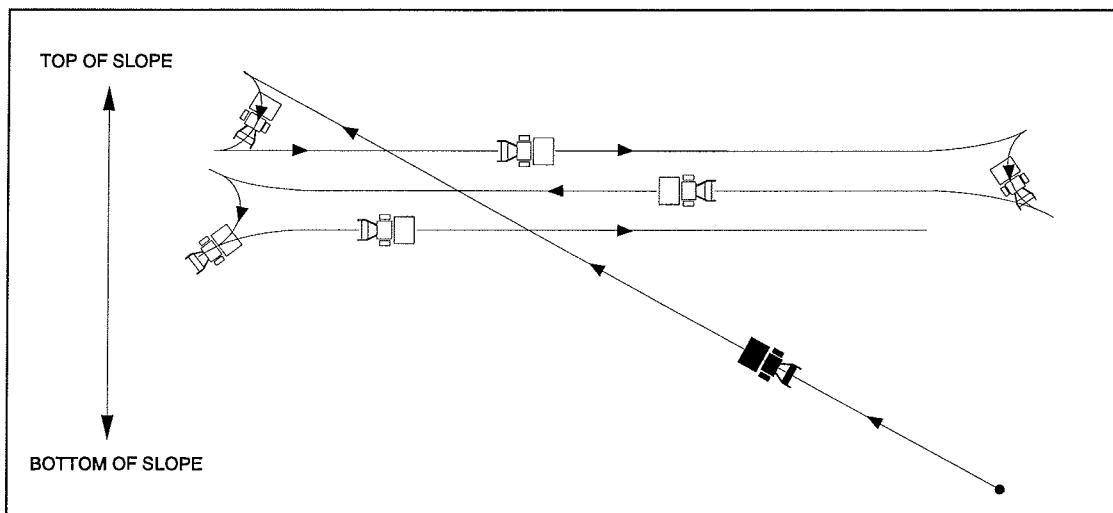

2D510L1A

sz 20/6/96

### ADJUSTING HEIGHT OF CUT

#### Rotary Attachments.

Loosen Handknob (1) sufficiently to allow lever (2) to be moved to the required height of cut position. When at required height of cut retighten handknob to secure height of cut lever in position.

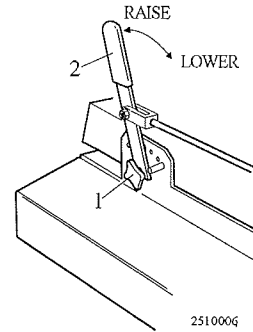

1. Handknob.
2. Height of Cut Lever.

### HANDLEBAR HEIGHT ADJUSTMENT

The height of the handlebars may be adjusted at the bolt connection between the handlebar stays and the side plates. 2 holes in the side plate provide 2 alternative handlebar settings. Ensure that the handlebars are set at the same level on each side of the machine.

**! WARNING: PREVENT ACCIDENTS -** Altering the handlebar position can affect the brake adjustment. Always adjust the braking system after altering the handlebar setting. Refer - MAINTENANCE.

**! WARNING: PREVENT ACCIDENTS -** Altering the handlebar position can affect the gear shift position. Always adjust the gear shift after altering the handlebar setting. Refer - MAINTENANCE.

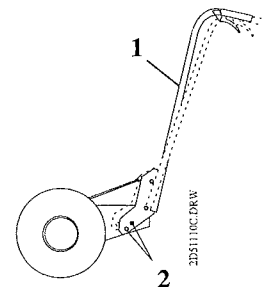

1. Handlebar.
2. Adjustment holes.

se 20/6/96, ✓

## MAINTENANCE



**WARNING: PREVENT ACCIDENTS** - Before carrying out maintenance procedures:

- Stop the engine, apply the parking brake and disconnect the spark plug lead.
- Read and understand the maintenance section of the Operator's Manual.

**IMPORTANT: PREVENT DAMAGE:** Regular maintenance is essential for the continued safe operation of the mower. Correct servicing will prolong the working life of the mower and safeguard the " Hayter Warranty ". Always fit genuine 'Hayter service parts' as these are accurately matched to the required duty.

The recommended service intervals are based on normal operating conditions. Severe or unusual conditions will necessitate shorter service intervals.



**WARNING: PREVENT ACCIDENTS** - Remember the engine oil is hot after mower use. Allow to cool before carrying out maintenance procedures.



**WARNING: PREVENT ACCIDENTS** - Use hazardous substances carefully. The following fluids are identified as being hazardous;

<u>Substances</u>	<u>Assessed risk</u>
Petrol	High
Lubricating oil	Low
Gear box oil	Low
Grease	Low

When using any of the above fluids it is recommended that the eye protection and gloves are worn and care is taken to prevent spillage.

Avoid contact with skin; wash off spillage with soap and water.

In case of petrol, keep away from all sources of ignition and wash with soap and water. Remove any contaminated clothing and wash thoroughly before use.

Avoid contact with eyes; wash with running water and seek medical attention.

Avoid ingestion; If swallowed seek medical attention.

**CAUTION: PREVENT ENVIRONMENTAL DAMAGE** - Dispose of hazardous substances correctly.

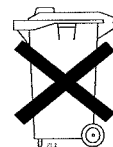

**ENGINE**

Refer to the engine manual for engine maintenance information. The engine is governed to run at a maximum speed of 2800 r.p.m. Under no circumstances must this speed be modified.

**RUNNING IN PERIOD - AT FIRST 50 HOURS OF USE.****Check wheel nut torque:**

Power unit wheel nut torque setting 80Nm (60lbs ft).

**Check belt tension- cutterhead drive:** Ensure that the cutterhead drive is disengaged and check the free play at the centre of the belt as shown. If adjustment is required, slacken the cutterhead securing bolts and move the cutterhead towards the front of the mower until the correct tension is obtained. Finally tighten the cutterhead securing bolts.

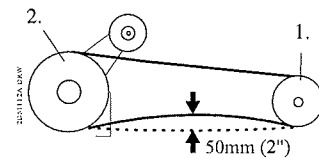

1. Bevel box pulley
2. Cutterhead pulley.

**Check cutterhead drive clutch cable adjustment:** Ensure that the cutterhead drive is Disengaged. Adjust the clutch cable by slackening off the locknuts at the anchor plate on the left hand handlebar and moving the adjuster to obtain 3mm free movement of the cable. Retighten the locknut.

**Note:** that the cutterhead drive clutch cable adjuster is to the left of the cutterhead brake adjuster.

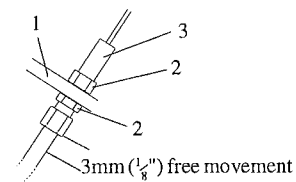

1. Anchor plate on handlebars.
2. Locknut.
3. Adjuster.

**Check cutterhead brake cable adjustment:** Ensure that the cutterhead drive is disengaged. Adjust the cutterhead brake cable by slackening off the locknuts at the anchor plate on the left hand handlebar and moving the adjuster to obtain 3mm free movement of the cable. Retighten the locknut.

Note that the cutterhead brake cable adjuster is to the right of the cutterhead drive clutch cable adjuster.

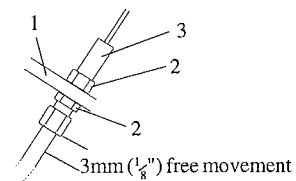

1. Anchor plate on handlebars.
2. Locknut.
3. Adjuster.

sc. 20/6/96

**RUNNING IN PERIOD - AT FIRST 50 HOURS OF USE.**

Continued.

**Check belt tension - Main engine drive:** Check the free play at the centre of the drive belt as shown using finger pressure. If adjustment is required slacken the 4 nuts securing the engine base plate to deck and jack the engine back using the jacking screw situated at the rear of the machine. Retighten the securing screws.

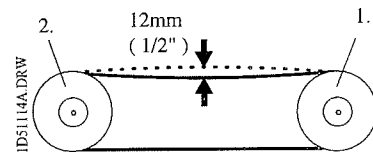

1. Engine pulley.  
2. Bevel box pulley.

**Check transmission cable adjustment:** Ensure that the machine drive is disengaged. Adjust the cable to obtain 3mm free movement of the cable as follows:-

Check that the clutch lever is set within the dimension range 60 - 70mm as shown. If not adjust nuts (1) to obtain the correct setting.

Move adjuster (2) to obtain 3mm free movement of the cable.

Check clutch operation. Ensure spark plug lead is removed and throttle control is set to stop position, engage 1st. gear, disengage drive clutch, disengage parking brake; The machine should easily be pulled backward. Pull engine start rope; the machine should not move forward. Engage drive clutch; Pull engine start rope; the machine should move forward.

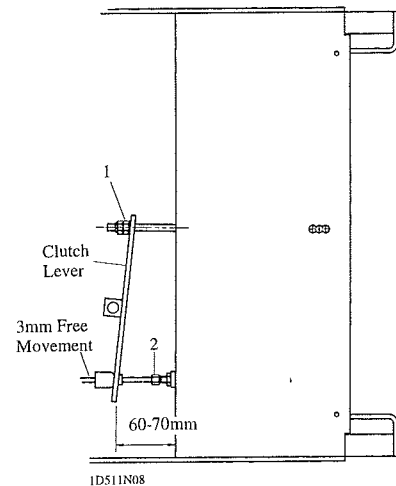
**DAILY AND BEFORE USE.**

**Check engine oil:** Never allow the oil level to drop below the 'L' mark on the dipstick. Top up with the correct grade of engine oil to the 'F' mark on the dipstick. Never fill above the 'F' mark. Refer - ENGINE OWNER'S MANUAL.

**Check fuel level:** Top up as necessary with unleaded petrol - standard grade. Always top up before storing the mower over night to prevent water condensation from contaminating the fuel.



**Air intake screen:** Clean as necessary.

**⚠ WARNING: PREVENT ACCIDENTS -** Keep bystanders away when checking the operator presence control system. **DO NOT** use the mower unless the operator presence controls work correctly as described below. Consult your Hayter dealer if the system malfunctions.

**Check the operator presence controls:** Stop the engine. Engage the cutterhead drive clutch and hold in engagement with the OPC lever. The engine should not start when the normal starting procedures are followed. Carry out a similar check with the transmission engaged in any gear.

Start the engine, engage the cutterhead drive and hold engaged with the OPC lever. Release the OPC lever and ensure that the cutterhead ceases to rotate within 5 seconds.

se 20/6/06

**DAILY AND BEFORE USE**

Continued.

**Check fasteners:** Check that all nuts, bolts, pins and linkages are secured correctly in place and are in good order.

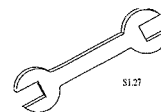

**Check tyres:** Examine the condition of the tyres and check that the inflation pressures are correctly set, refer - SPECIFICATIONS.

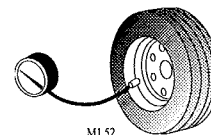

**Rotary attachment:** Check the condition of the cutterblades and mounting arrangements for signs of wear, damage or looseness. Ensure that the cutterblades are not bent or cracked and that the cutterblade securing bolts are tight. Damaged or excessively worn cutterblades may be out of balance which will cause excessive vibration this may lead to breakage or result in serious damage to the machine.

**⚠ WARNING - PREVENT ACCIDENTS.** Never use the mower if the cutterblades and mounting arrangement are seriously worn, damaged, out of balance or loose.

Remove all grass cuttings and build up of debris from the cutterhead area, and the cooling air intake areas / internal surfaces of the engine.

**⚠ WARNING - PREVENT ACCIDENTS.** Check all guards and safety devices. Never operate the mower unless the guards are securely in position, in good condition and all safety devices are in place and in good working order.

**Check control cables:** Ensure that the control cables are correctly adjusted and in good condition. Always replace damaged cables.

**EVERY 50 HOURS**

Perform routine checks: **Refer - DAILY BEFORE USE.**

**Check power unit wheel nut torque:** Wheel nut torque setting - 80 Nm (60lbs ft).

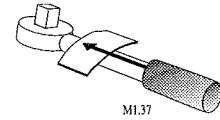

**Rotary attachment:** Inspect the chain couplings between the cutterhead gearboxes. Inspect sprocket teeth and chains for signs or wear.

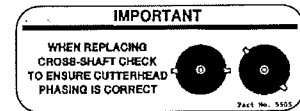

**IMPORTANT: PREVENT DAMAGE** - If the chains / countershaft are removed for any reason, ensure after refitting that the cutterhead phasing is correct.

**Lubrication:**

**Cutterhead Gearbox (Rotary Attachment):** Remove filler plug on top of the gearbox and check oil level. Gearbox should be 3/4 full. If necessary top up with the correct grade of oil, refer - 'SPECIFICATIONS'.

**General:** Lightly apply a good quality general purpose lubricating oil to the following:

All inner cables and linkage pivot points.

Apply a good quality medium grade grease to the following grease points:

Front wheels (Rotary Attachment).

Coupling chains - between cutterhead gearboxes (Rotary Attachment).

**EVERY 200 HOURS**

Perform routine checks: Refer-DAILY BEFORE USE, EVERY 50 HOURS USE.

**Check Belt Tensions:** Refer - RUNNING IN PERIOD.

**Check cutterhead drive clutch cable adjustment:** Refer - RUNNING IN PERIOD.

**Check condition of cutterhead drive brake pad:** Replace if excessively worn.

**Check Cutterhead drive brake adjustment:** Refer - RUNNING IN PERIOD.

**Check bevel box oil level:** Remove filler plug on top of gearbox and replenish with recommended lubricant. Refer - SPECIFICATIONS. Fill up to the level of the cross shaft. Refit filler plug.

**Check transmission clutch cable adjustment:** Refer - RUNNING IN PERIOD.

SE 20/6/96



## GENERAL MAINTENANCE

**Adjustment of engine lockout switch sensors:** The micro switches must be positioned such that when the gearbox gear shift lever mechanism is in the neutral position and the jockey arm is in the disengaged position the switches must be fully closed, refer - Fig A and B.

To adjust the gear shift microswitch set the lever in the neutral position, slacken off the switch mounting bolts and slide the switch along its mounting slots until the switch is heard to click shut. Retighten mounting bolts.

To adjust the jockey arm microswitch slacken the adjuster screw, adjust until the switch is heard to click shut. Retighten the adjuster screw.

Check to see that the engine will only start when the gear shift lever is in neutral and the cutter clutch is disengaged.

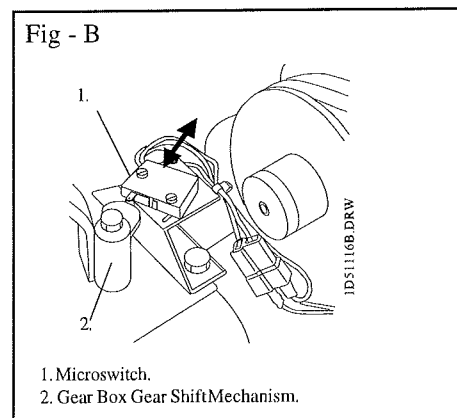
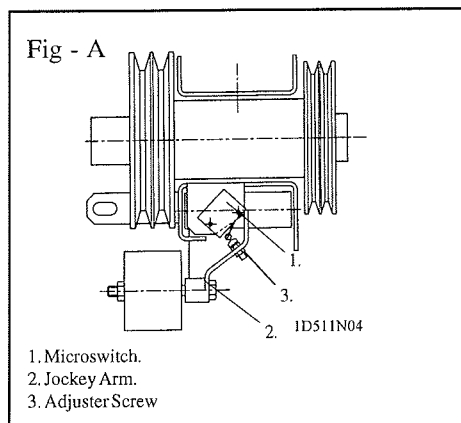

**Parking Brake - Cable Adjustment:** To adjust the cable, slacken off the locknut and turn the cable adjuster. A correctly set cable should have no slack. When the brakes are applied the brake lever should operate smoothly and lock at the end of its travel.

Check that the parking brake has been applied. Put the 5 speed gearbox into neutral and pull or push the machine. The wheels should be locked. Readjust the cable if the machine is able to be moved.

**Gearbox:** The 5 speed gearbox is packed with grease at the factory should require no regular attention.

#### Transmission Clutch Adjustment - Idler Pulley:

When fitting a new transmission drive belt the idler pulley position may need to be altered to compensate for the variation in belt lengths.

Adjustment procedure is as follows:-

Adjust clutch cable - refer - RUNNING IN PERIOD.

If the belt fails to drive the machine move the jockey forward.

If the belt fails to disengage the machine move the jockey back.

Re-adjust the clutch cable.

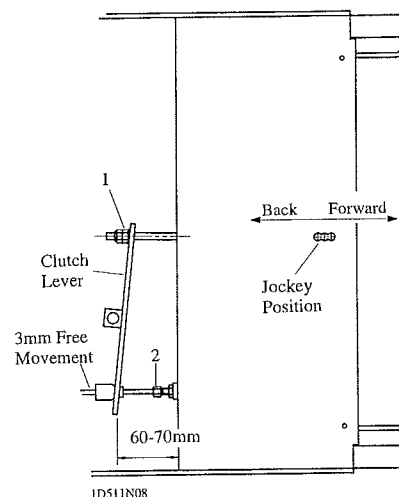

**ROTARY ATTACHMENTS**

**! WARNING: PREVENT ACCIDENTS - NEVER** work on the cutterblades unless the spark plug lead has been removed. The cutterblades have sharp edges. **ALWAYS** wear strong gloves to protect your hands when working on the cutterblades. **DO NOT** operate tools towards the cutting edges to avoid the risk of injury should the tool slip. **ALWAYS** use genuine Hayter replacement parts.

**! WARNING: PREVENT ACCIDENTS - ALWAYS** renew both cutterblades on each bottom plate to ensure the cutting mechanism is balanced, **NEVER** replace cutterblades individually. **ALWAYS** use new bolts, nuts and washers when fitting new cutterblades.

**PREVENT DAMAGE:** A damaged cutterblade will cause the cutting mechanism to be out of balance and excessive vibration will occur which may lead to breakage. **DO NOT** use an unbalanced cutting mechanism.

Replace the cutterblades every 2 years or sooner if excessively worn or damaged.

**! WARNING: PREVENT ACCIDENTS - It is wise to seek assistance when removing and inverting the cutterhead attachment.**

The condition of the cutterblades and the mounting arrangement should be checked regularly for signs of wear or damage. Ensure that the cutterblades are not bent or cracked.

Regularly check that the bolts securing the cutterblades and bottom plate are secure.

**To remove the cutterblades:** Remove the cutterblade nut (2) and bolt (5).

**How to assemble the cutterblades:** Assemble cutterblades (4) such that they are below and pointing away from the bottom plate (1). Tighten the cutterblade nuts (2) and bolts (5) to a torque of 19Nm ( 14lbs. ft.).

Tighten the bottom plate bolt (7) to a torque of 54Nm (40lbs. ft.).

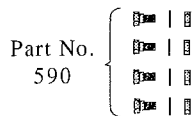
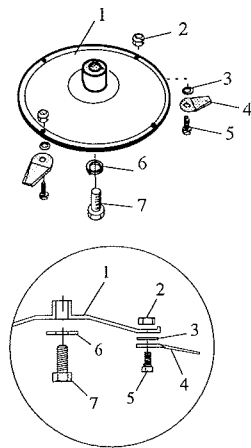

M1.48

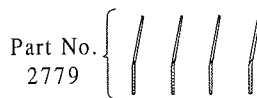

2779

- 1. Bottom Plate.
- 2. Nut.
- 3. Washer.
- 4. Blade.
- 5. Bolt.
- 6. Tab Washer.
- 7. Bottom Plate Bolt.

**CUTTERBLADES**

**Cutterblade phasing:**

**Important: Prevent Damage - The cutterheads must be correctly phased.**

Ensure that the cutterblades are fitted into the correct mounting holes the underdeck as shown.

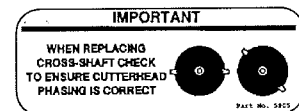

*see 20/6/96*

**PREPARING THE MOWER FOR STORAGE**

**Storage for long periods:** To ensure that the mower is maintained in good working order it is important that the following procedure is adopted when the mower is stored for periods in excess of one month. Refer to the maintenance section and engine handbook as necessary.

**⚠ WARNING: PREVENT ACCIDENTS - Ensure that the mower is outdoors, away from all possible sources of ignition and that the engine is cool prior to carrying out the following procedure.**

Drain fuel from the engine and carburettor.

Disconnect the spark plug lead. Change the engine oil.

Remove the engine spark plug and pour a tablespoon of clean engine oil into the spark plug aperture. **Do not** exceed the stated volume of oil as engine damage may occur on restarting. Operate the engine start grip several times to crank the engine. This will distribute the oil.

Cover the spark plug hole with the thumb and slowly turn the engine over until the piston is at the top of its stroke ( pressure against the thumb is greatest ). Reinstall the spark plug but do not connect the plug lead.

Clean all areas of the power unit engine and cutterhead attachment.

Lubricate the mower.

Treat bare metal parts with a water repellent anti-corrosion product.

Rest the machine on wooden blocks to remove the weight of the mower from its wheels.

Cover the mower with a protective sheet and store it in a dry, ventilated area.

## GRASS CUTTING FAULTS

## Rotary attachment:

FAULT	POSSIBLE CAUSE	REMEDY
Uneven Cut	Undulating ground contours	Change direction of cut.
	Cutterblades worn or damaged.	Sharpen or replace as necessary.
	Cutterblades out of balance.	Balance cutterblades.
	Wheel damaged.	Inspect and replace as necessary.
Scalping	Height of cut too low.	Raise height of cut.

## TROUBLE SHOOTING

When using the following chart it may be decided that overhaul of major components are necessary. In this case it is recommended that your Hayter dealer make these repairs as he is properly equipped to do this work.

 **WARNING: PREVENT ACCIDENTS - ALWAYS Switch off the mower engine, move the throttle control lever to the 'stop' position and apply the parking brake before attempting to work on the mower.**

PROBLEM	POSSIBLE CAUSE	REMEDY
Engine will not start.	Cutterhead drive interlock switch sensor not energised.	Disengage cutterhead drive.  Check setting of interlock micro switch.
	Gear Shift control interlock switch sensor not energised.	Ensure gear shift lever is in the neutral position.  Check setting of interlock micro switch.
	Insufficient 'choke'.	Reset the choke lever.
For all other engine problems, refer - ENGINE HANDBOOK.		

## TROUBLE SHOOTING

Continued.

PROBLEM	POSSIBLE CAUSE	REMEDY
Lack of transmission drive.	Parking brake engaged.	Release parking brake.
	Drive belt incorrectly tensioned.	Re-tension drive belt.
	Broken drive belt.	Replace drive belt.
	Incorrect clutch cable adjustment.	Readjust as necessary.
Incorrect parking brake operation.	Worn brake shoes.	Replace brake shoes. Consult your Hayter dealer.
	Incorrect cable adjustment.	Readjust cable setting.
Low cutterhead power.	Incorrect belt tensions.	Readjust belt tensions.
	Incorrect cutterhead drive-clutch/brake adjustment.	Readjust as necessary.
Lack of cutterhead drive.	Broken drive belt.	Replace drive belt.
	Incorrect cutterhead drive - clutch / brake adjustment.	Readjust as necessary.
Cutterhead vibrates excessively.	Worn, damaged or loose cutterblades.	Replace, sharpen or tighten immediately.

sc 206/96

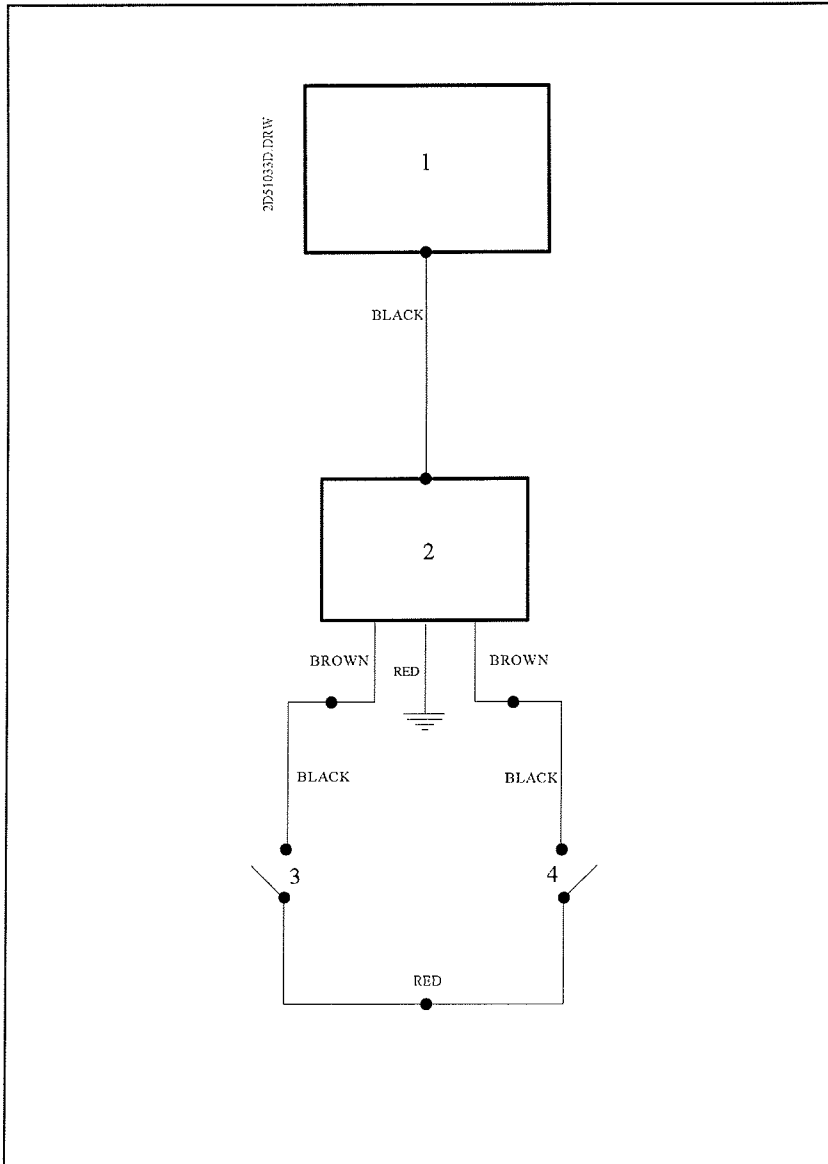

1. Engine.
2. Control module.
3. Cutter clutch engine lockout micro switch.
4. Transmission engine lockout micro switch.

*SE 20/6/96*

**WARRANTY**

**HAYTER LIMITED** Warrants to the original user / purchaser that this unit shall be free from defects in material and workmanship for a period of 12 calendar months from the date of delivery. This warranty excludes proprietary items which have the benefit of the supplying manufacturers warranty and wearing parts.

Engine manufacturers furnish their own warranties and provide services through their authorised network. If you experience any difficulty please contact your specialist Hayter dealer.

It is the end user / purchasers responsibility to ensure that the service schedule and **Hayter** service record book as applied are acted upon. **HAYTER LIMITED** reserve the right to request inspection of a service record book, where relevant at any reasonable time. Failure to keep the service schedule up to date may invalidate the warranty. Owners should therefore satisfy themselves that the products are operated and serviced correctly, particularly where they are operated on a contract or hire basis.

This warranty which is not capable of assignment does not apply to any unit that has been tampered with, altered, misused or abused and **will become invalid if non genuine Hayter parts are fitted**. This warranty does not cover minor adjustments unless they are due to defective materials or workmanship. Consult the Operator's Manual or your authorised **Hayter** dealer for assistance when making these adjustments.

To make a warranty claim contact your authorised **Hayter** dealer through whom the machine was originally supplied, indicating the machine serial number and purchase date. Subject to the conditions and exclusions in this warranty, the authorised **Hayter** dealer will at our option, repair or replace any warranted part within the duration of the warranty period.

This warranty gives you specific legal rights and is in addition to any statutory rights to which you may be entitled and your statutory rights are not affected by this warranty. If you need additional information concerning this written warranty or assistance in obtaining services please write or telephone :

**HAYTER LIMITED, Service Department, Spellbrook, Bishop's Stortford, Herts., CM23 4BU**  
**Telephone : ( 01279 ) 723444.**