

# HUNTER 41

---

CODE - 302N (Push)

## OWNER'S HANDBOOK

FROM SERIAL NO:302L001001  
ISSUE: 20/11/95

HANDBOOK: 302061 (REV.0.)

## CERTIFICATE OF CONFORMITY

I, the undersigned **A. D. BONE**, of ;  
HAYTER LIMITED, Spellbrook, Bishop's Stortford,  
Herts, CM23 4BU,  
ENGLAND.

**certify that the lawnmowers;**

1. Model No.
2. Category.
3. Make.
4. Type.
5. Engine
  - Manufacturer.
  - Type.
  - Speed of rotation during test.

CODE 302N  
302N  
Combustion Engine  
Hayter  
Rotary  
Briggs & Stratton  
098902 - 0393 - 01  
3000 rpm

Conforms to the specifications of Directive 84/538/EEC as adapted  
to technical progress by Directive 87/252/EEC and amended by  
Directive 88/180/EEC.

**Guaranteed maximum sound power level.**

96 dB(A)  
Cutterbar  
41 cm  
3000 rpm

- Type of cutting device.
- Width of cutting device.
- Speed of rotation of the cutting device.

TESTED AT SUBBURY,  
SUFFOLK, ENGLAND.

Date: 09-03-95

Signed:

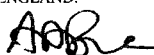

A.D. Bone  
( Technical Manager ).

## EC DECLARATION OF CONFORMITY

Company Name HAYTER LIMITED.

Company Address Spellbrook  
Bishop's Stortford  
Herts. CM23 4BU  
ENGLAND.



Machine Type No. Code 302N  
Models Hunter 41 Push

**Directives complied with:**

89/392/EEC amended by 91/368/EEC, 93/44/EEC and 93/68/EEC.  
Essential Health & Safety Requirements Relating to the Design & Construction of Machinery and Safety Components.  
84/538/EEC amended by 87/252/EEC and 88/180/EEC Permissible Sound Power Levels of Lawn Mowers.  
92/31/EEC Electromagnetic Compatibility.

Standards Used: BS5107, EN292, EN50081 and EN50082.

I declare on behalf of Hayter Limited that these machines conform to the EC Essential Health & Safety Requirements.

Signed:



Date: 27-03-95

A.D. Bone  
( Technical Manager ).

Lawnmower vibration information. RMS acceleration measured in 3 - axes at operators contact position on the handlebars. Code 302N = 7.8 ms<sup>-2</sup>

**CONTENTS****Page No.**

<b>INTRODUCTION.</b>	<b>1.2</b>
<b>WARRANTY.</b>	<b>1.3</b>
<b>SAFETY PRECAUTIONS.</b>	<b>1.4 - 1.7</b>
<b>SPECIFICATIONS.</b>	<b>1.8</b>
<b>ASSEMBLY INSTRUCTIONS.</b>	<b>1.9</b>
General assembly.	1.9
Assembling the mower for the first time.	1.10 - 1.11
<b>STARTING THE ENGINE.</b>	<b>1.12</b>
Before starting the engine.	1.12
To start the engine.	1.13
<b>STOPPING THE ENGINE.</b>	<b>1.14</b>
<b>OPERATING THE MOWER.</b>	<b>1.15</b>
Height of Cut.	1.15
Travel.	1.16
Turning the mower.	1.16
Mowing with grass collection.	1.17
Mowing without grass collection.	1.18
Heavy growth.	1.18
Transporting the mower.	1.18
Cutterbar operation.	1.19
Mowing and grass care tips.	1.19 - 1.20
<b>MAINTENANCE.</b>	<b>1.21</b>
Engine.	1.21
Grassbag.	1.21
Deck housing.	1.21
Securing nuts and bolts.	1.22
Lubrication.	1.22
Cutterbar.	1.23 - 1.24
<b>PREPARING THE MOWER FOR STORAGE.</b>	<b>1.25</b>
<b>FAULT FINDING.</b>	<b>1.26- 1.27</b>
<b>302N PARTS LIST.</b>	<b>2.1 - 2.2</b>
<b>302N MAINFRAME DIAGRAM.</b>	<b>2.3</b>
<b>302N UPPER MAINFRAME DIAGRAM.</b>	<b>2.4</b>

**INTRODUCTION**

Thank you for purchasing a **Hayter** mower. The following pages are designed to help you gain safe and efficient service from your machine.

**IMPORTANT : Read and understand this handbook prior to operating your machine for the first time. Make sure you are familiar with all the controls and points of regular maintenance.** If you have any doubts, consult a **Hayter** authorised dealer who will be pleased to give you assistance.

All **Hayter** mowers are robustly constructed and designed for efficient economical performance under normal mowing conditions. Correct operation and maintenance will ensure a long and satisfactory service life. Prior to despatch from our factory every effort is made to ensure your machine arrives in perfect condition.

Throughout this handbook all references to left hand and right hand are as viewed from behind the handlebar, facing in the direction of forward travel.

This handbook is based on information available at the time of publication.

**HAYTER LIMITED** reserve the right to make changes at any time without notice.

**LIMITED WARRANTY**

**Hayter Limited** warrants to the original user/purchaser that this unit shall be free from defects in material and workmanship under normal use and service for a period of two years from the date of purchase. To qualify for the full benefit of the warranty, the warranty registration card must be returned within 60 days of purchase. This warranty does not cover engines or wearing parts i.e. cutterbars, wheels and tyres. If you have any doubt, consult a **Hayter** authorised dealer for clarification. Subject to the conditions and exclusions noted in this limited warranty, we shall at our option, repair or replace any warranted part during the applicable period. Engine manufacturers furnish their own warranties and provide services through their authorised network. If you experience any difficulty, please contact a **Hayter** authorised dealer.

To qualify for the second twelve month period of the above two year limited warranty, the machine must be serviced by a **Hayter** authorised dealer. This chargeable service should be carried out within 14 months of purchase and be in accordance with the recommendations for service determined by **Hayter**.

This warranty does not apply to any unit that has been tampered with, altered, misused, abused or used for hire and will become invalid if non genuine **Hayter** parts are fitted. This warranty does not cover minor mechanical adjustments unless they are due to defective materials or workmanship. Consult the owners handbook or a **Hayter** authorised dealer for assistance when making these adjustments.

**A warranty period of 90 days applies to machines used for commercial purposes.**

To make a warranty claim, return the unit to a **Hayter** authorised dealer along with proof of purchase indicating the machine serial number and purchase date. Subject to the conditions and exclusions in this limited warranty, the authorised dealer will, at our option, repair or replace any warranted part within the duration of the warranty period.

This limited warranty gives you specific legal rights and is in addition to any statutory rights to which you may be entitled and your statutory rights are not affected by this warranty. If you need additional information concerning this written warranty, or assistance in obtaining services, please write to: **HAYTER LIMITED, Service Department, Spellbrook, Bishop's Stortford, Herts. CM23 4BU.**

Details of your local **Hayter** authorised dealer are contained in Yellow Pages or contact :-  
Freephone 0800 616298.

**SAFETY PRECAUTIONS**

**THIS SYMBOL MEANS BE ALERT! YOUR SAFETY IS INVOLVED. EXERCISE GREAT CARE AND FOLLOW THE ADVICE GIVEN TO AVOID POTENTIALLY HAZARDOUS SITUATIONS.**

**The Hunter 41 S.E is perfectly safe if used correctly. Failure to observe the following simple precautions may result in serious injury.**

**Training:**

Read the instructions carefully. Ensure that you are familiar with the controls and the proper use of the equipment. Learn how to stop the mower quickly in an emergency.



Never allow children or people unfamiliar with these instructions to use the mower.



Never mow while people, especially children, or pets are nearby.



Keep in mind that the user is responsible for accidents or hazards occurring to other people or their property.

**Preparation:**

While mowing, always wear substantial footwear and long trousers. Do not operate the equipment when barefoot or wearing sandals.



Thoroughly inspect the area where the mower is to be used and remove all objects which may be thrown by the machine.



**WARNING:** Petrol is highly flammable.

-Store fuel in containers specifically designed for this purpose.

-Refuel outdoors only and do not smoke while refuelling.

-Add fuel before starting the engine. Never remove the cap from the fuel tank or add petrol while the engine is running or when the engine is hot.

-If petrol is spilled, do not attempt to start the engine but move the mower away from the area of spillage. Avoid creating any source of ignition until petrol vapours have dissipated.

-Replace all fuel tank caps and fuel container caps securely.



Replace faulty silencers.

**SAFETY PRECAUTIONS**

Continued.

 Always ensure that the mower is in a safe operating condition. Frequently check all nuts, bolts and screws for tightness. Use only genuine **Hayter** replacement parts.

 A damaged cutterbar and loose fixing bolt are a major hazard. Before use, visually inspect the cutting mechanism to ensure that it is in good condition. A damaged cutterbar must be replaced immediately with a genuine **Hayter** replacement part. A cutterbar which is slightly worn can be resharpened. Ensure that both cutting edges are resharpened equally to maintain balance. An unbalanced cutterbar may cause serious damage to your machine.  
Refer to "Maintenance."

**Operation:**

 Do not operate the engine in a confined space where dangerous carbon monoxide fumes can collect.

 Mow only in daylight or good artificial light.

 Avoid using the mower on wet grass, where feasible.

 Always be sure of your footing on slopes.

 Walk, never run.

 Mow across the face of slopes, never up and down.

 Exercise extreme caution when changing direction on slopes.

 Do not mow excessively steep slopes.

 Use extreme caution when reversing or pulling the mower towards you.

 Stop the engine if the mower has to be tilted for transportation when crossing surfaces other than grass and when transporting the mower to and from the area to be mowed.

 Never operate the mower unless the guards are securely in position and in good condition.

 Do not change the engine governor settings or overspeed the engine.

**SAFETY PRECAUTIONS**

Continued.

**Operation continued:**

Start the engine carefully, with feet well away from the cutterbar.



Do not tilt the mower when starting the engine.



Do not put hands or feet near or under rotating parts.



Never pick up or carry a mower while the engine is running.



Stop the engine and disconnect the spark plug lead:

- Before clearing blockages or unclogging the discharge chute.
- Before cleaning/checking or working on the mower.
- After striking a foreign object. Inspect the mower for damage and make repairs before restarting and operating the mower.
- If the mower starts to vibrate abnormally ( check immediately ).



Stop the engine:

- Whenever you leave the mower.
- Before refuelling.



When using the machine without the grassbag, do not lift the deflector plate whilst the mower is in operation.









**WARNING: THE CUTTERBAR CAN CONTINUE TO ROTATE AFTER THE ENGINE IS SWITCHED OFF.**



**SAFETY PRECAUTIONS**

Continued.

**Maintenance and storage:**

-  Keep all nuts, bolts and screws tight to ensure that the equipment is in safe operating condition.
-  Never store the mower with petrol in the tank within an enclosed area where fumes may reach an open flame or spark.
-  Allow the engine to cool before storing in any enclosure.
-  To reduce the fire hazard, keep the engine, silencer and petrol storage area free of grass, leaves, or excessive grease.
-  Check the grassbag frequently for wear or deterioration.
-  Replace worn or damaged parts for safety.
-  If the fuel tank has to be drained, it is essential that this be done outdoors.

**DECALS**

**WARNING DECAL: Part No. 219189**

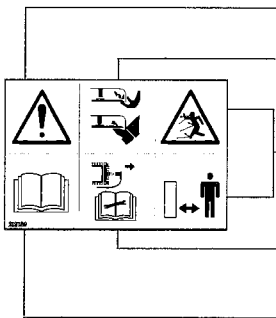

**WARNING - CAUTION RISK OF DANGER - SAFETY ALERT.**

**DANGER OF SEVERING TOES OR FINGERS IN CUTTING MECHANISM.**

**DANGER OF BEING HIT BY THROWN OBJECTS. KEEP BYSTANDERS AT A SAFE DISTANCE FROM THE MACHINE.**

**STOP ENGINE AND REMOVE SPARK PLUG LEAD BEFORE PERFORMING MAINTENANCE OR REPAIR WORK.**

**CAREFULLY READ THE OPERATORS MANUAL BEFORE USING THE MACHINE.**

**DECAL - ENGINE STOP**  
Part No. 331046



**DECAL - CUT HEIGHT ADJUSTMENT:**  
Part No. 320006



**DECAL - FILL OIL HERE:**  
Part No. 302063



**DECAL - HEIGHT OF CUT INDICATOR:**  
Part No. 305113

**DECAL - FILL PETROL HERE:**  
Part No. 302064

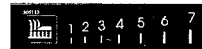

## SPECIFICATIONS

<b>MODELS</b>	<b>CODE 302N</b> Push
<b>Engine</b>	Briggs & Stratton Sprint 375.
<b>Engine type</b>	098902 - 0393 - 01
<b>Engine / cutterbar speed</b>	3000 rpm
<b>Fuel type</b>	Unleaded petrol
<b>Fuel capacity</b>	1.5 litres ( 2.6 UK pints )
<b>Oil type</b>	SAE 30 engine oil
<b>Oil sump capacity</b>	0.6 litres ( 1.1 UK pints )
<b>Cutting width</b>	410mm ( 16 inch )
<b>Cutting height</b>	19 - 61mm ( 0.75 - 2.4 inch )
<b>Overall dimensions</b>	1,340 x 451 x 1,041mm ( 52.75 x 17.75 x 41 inch )
<b>Dry Weight</b>	23.5 Kg ( 51.7 lbs )

## ASSEMBLY INSTRUCTIONS

## SAFETY NOTICE



Before using the mower, read this Owner's Handbook carefully. Pay particular attention to the safety precautions.

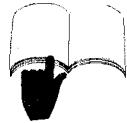

## GENERAL ASSEMBLY

- 1 Handlebar.
- 2 Grassbag Assembly.
- 3 Rear Deflector.
- 4 Serial Number Decal.
- 5 Oil Filler Cap and Dipstick.
- 6 Height of Cut Adjuster.
- 7 Spark Plug Lead.
- 8 Primer Bulb.
- 9 Fuel Filler Cap.
- 10 Handlebar Securing Knob.
- 11 Rope Guide.
- 12 Engine Start-Grip.
- 13 Engine Stop lever.
- 14 Air cleaner.
- 15 Decal - Height of cut indicator.

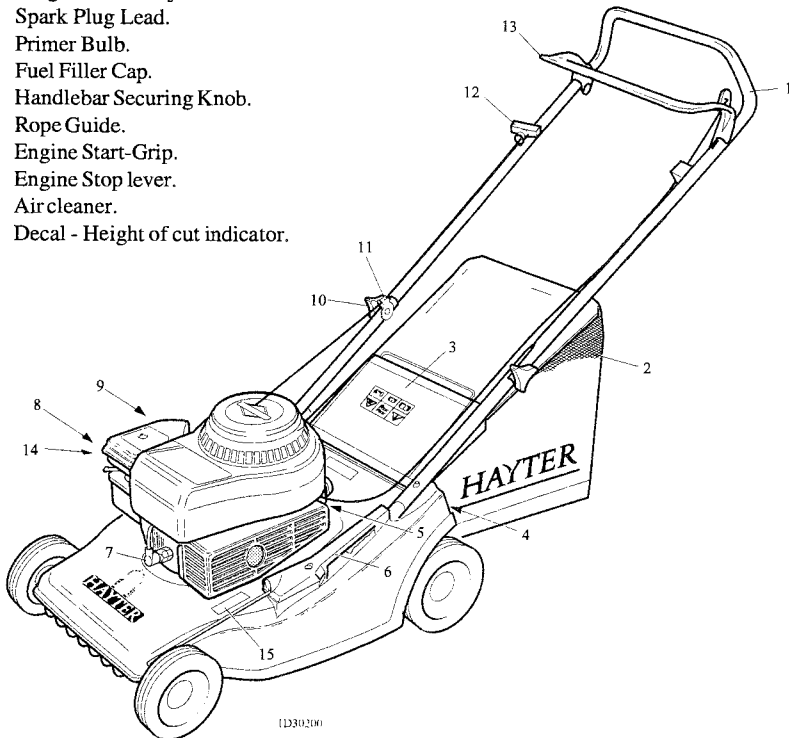

12302000

## ASSEMBLING THE MOWER FOR THE FIRST TIME

**Check that parts are delivered correctly:** Having removed the mower from the packaging, check that all loose items have been supplied correctly. Refer to the delivery checklist opposite and the general assembly. If any items are missing, contact your local authorised Hayter Dealer.

### DELIVERY CHECKLIST

Description	Quantity
Grassbag	1
Owner's Handbook	1
Engine Handbook	1
Instruction Sheet	1
Oil Pack	1
Warranty Reg. card	1

**Assemble the handlebar:** Unscrew the knobs securing the handlebar sufficiently to allow it to be pivoted. Move the engine stop lever away from the engine to avoid damage and unfold the handlebar to its operating position. Tighten the two knobs to secure the handlebar.

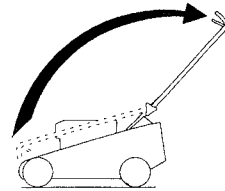

**CAUTION - PREVENT DAMAGE :** When unfolding the handlebar, take care to ensure that the engine stop lever and cable do not become damaged. Always replace damaged controls and cables before using the mower.

**Assemble the grassbag:** Identify the grassbag and remove the long ribbon label by cutting it off close to the grassbag. Discard the ribbon label.

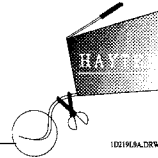

**WARNING - AVOID ENTANGLEMENT :** Completely remove this ribbon before using the mower.

Raise the rear deflector and hook the grassbag over the upper mounting points. Lower the grassbag to rest against the rear of the mower. Finally lower the rear deflector to rest against the top of the grassbag.

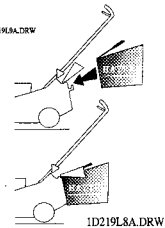

**ASSEMBLING THE MOWER FOR THE FIRST TIME**

Continued.

**Check engine stop lever operation:** Operate the engine stop lever several times. Ensure that the cable moves freely and that the lever returns automatically to the engine stop position when released.

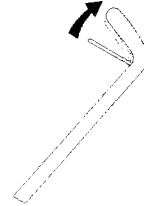

**IMPORTANT: PREVENT ENGINE DAMAGE-** The engine is shipped without oil or petrol. The engine must be filled with the correct grade of oil and petrol before starting the engine - refer to "Before starting the engine".

**Fill the engine with oil:** With the mower on a level surface, unscrew and remove the oil filler - dipstick. Fill the engine with the full contents of the oil pack supplied with the mower. Screw the oil filler - dipstick back in place, then unscrew and remove it to check the oil level.

The oil level is correct when it is between the **add** and **full** marks on the dipstick.

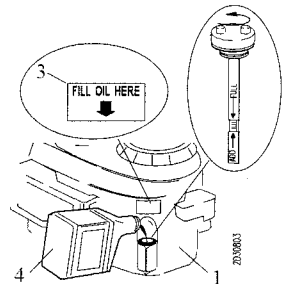

1. Engine.
2. Dipstick.
3. Decal - Fill Oil Here.
4. Oil Pack.

**IMPORTANT: The oil filler - dipstick must be secured when the engine is running.**

**Fill the engine with petrol:** Remove the fuel filler cap and fill the fuel tank with clean unleaded petrol.

Do not overfill the fuel tank. Allow 6mm minimum of tank space for fuel expansion.

**IMPORTANT: The fuel filler cap must be secured when the engine is running.**



## STARTING THE ENGINE

### BEFORE STARTING THE ENGINE

Read the engine operating and maintenance instructions handbook supplied with this mower.

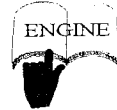

**WARNING:** The cutterbar rotates when the engine is operating.

**ALWAYS** operate the engine stop lever several times and ensure the engine stop cable moves freely before starting the engine.

**ALWAYS** position the mower on a level stone free grass surface before starting the engine. The engine will be difficult to start if the cutterbar is prevented from rotating freely. Ensure that the cutterbar is set above the level of the grass, for easy starting.

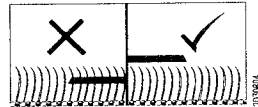

**Check oil level:** With the mower on a level surface, unscrew and remove the oil filler - dipstick. Wipe oil from it with a clean cloth. Screw the oil filler - dipstick back in place, then unscrew and remove it to check the oil level.

The oil level is correct when it is between the **add** and **full** marks on the dipstick.

Add SAE30 engine oil as necessary and replace the oil filler dipstick.

**IMPORTANT:** The oil filler - dipstick must be secured when the engine is running.

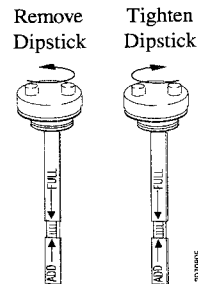

FILL OIL HERE  
↓

**Check fuel level:** Remove the fuel filler cap and fill the fuel tank with clean unleaded petrol.

Do not overfill the fuel tank. Allow 6mm minimum of tank space for fuel expansion.

**IMPORTANT:** The fuel filler cap must be secured when the engine is running.

FILL PETROL  
HERE ↓

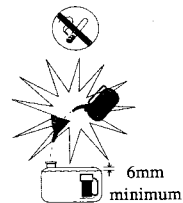

### TO START THE ENGINE

**Operate the primer bulb:** *Note: Push on the primer bulb 5 times at two second intervals to provide the extra fuel to start the engine after assembling the mower for the first time.*

In normal use push on the primer bulb 3 times at 2 second intervals to provide the extra fuel required to start a cold engine. Operation of the primer bulb is usually unnecessary when starting a warm engine.

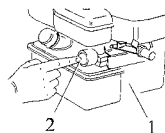

1. Engine
2. Primer Bulb

**Operate the engine stop lever:** Use one hand to hold the engine stop lever in the operating position firmly against the handlebar. To start and operate the engine, the engine stop lever must be held in the operating position. If the engine stop lever is released the engine will stop.

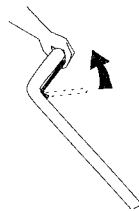

**Operate the engine start - grip:** Stand behind the mower and maintain a firm hold on the handlebar and the engine stop lever with your left hand to prevent the mower moving towards you. Use your right hand to hold the engine start-grip and pull rapidly to crank the engine. When the engine starts carefully return the engine start - grip to the storage position. If the engine does not start after 5 attempts, refer - "Fault Finding".

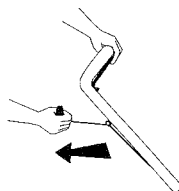

**IMPORTANT: Prevent engine damage. Never pull the engine start-grip when the engine is running.**

## STOPPING THE ENGINE

**Stopping the engine:** Disengage the engine stop lever by releasing the lever.

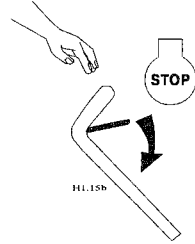

**Emergency stop:** If the engine stop lever fails, disconnect the spark plug lead to stop the engine.

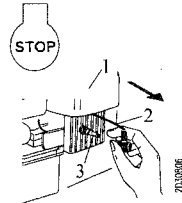

1. Engine.
2. Spark Plug Lead.
3. Spark Plug.

## SAFETY NOTICE



**WARNING: PREVENT ACCIDENTAL STARTING -**  
Always stop the engine and disconnect the spark plug lead before cleaning, inspecting or working on the machine.

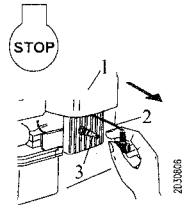

1. Engine.
2. Spark Plug Lead.
3. Spark Plug.



## SAFETY NOTICE

**! WARNING: PREVENT ACCIDENTS** - Before mowing, thoroughly inspect the area where the mower is to be used and remove all stones, sticks, wires, bones and other foreign objects, which when contacted by the mower cutterbar could become dangerous projectiles. Inspect the area for hidden obstructions which when contacted by the cutterbar could risk health and safety. Remember the location of these obstructions and ensure that you mow around them.



**CAUTION: Prevent engine damage** - DO NOT use the mower on a slope greater than 20 degrees.

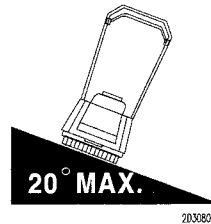

## HEIGHT OF CUT

**To adjust the height of cut :** Hold the trigger against the handle and raise or lower the mower using the handle to achieve the desired height of cut. Release the trigger to secure the mower at the required position.

There are seven height of cut positions. The setting is indicated by the position of the connecting rod relative to the height of cut indicator.

Always select a height of cut to suit operating conditions. Aim to prevent engine overloading and blockages by avoiding low cuts in long grass conditions. Be prepared to make two cuts when the grass is long.

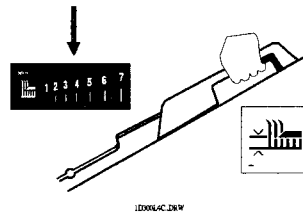

**TRAVEL**

**Forward travel :** Hold and push against the handlebar with both hands to move the mower forwards.

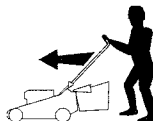

**Reverse travel :** Hold and pull against the handlebar with both hands to reverse the mower towards you.

**! WARNING: PREVENT ACCIDENTS - Always reverse the mower carefully towards you. Always switch off the engine before walking backwards with the mower.**

**TURNING THE MOWER**

**To make a wide turn :** Steer the mower with the handlebar whilst travelling forward.

**To make a tight turn :** Stop forward travel. Apply downward pressure on the handlebar to raise the front wheels of the mower just above ground level and steer the mower using the handlebar in the required direction.

**! WARNING: PREVENT ACCIDENTS - DO NOT raise the front of the mower excessively when making a turn. NEVER raise the rear of the mower when the engine is running.**

## MOWING WITH GRASS COLLECTION

The grassbag is designed to collect grass clippings.

To achieve best grass collection performance, mow in dry operating conditions.

- Recognise that when the grassbag is full the airflow stops and the grassbag deflates.

**WARNING: PREVENT ACCIDENTS - ALWAYS check the condition of the grassbag for signs of damage. Replace a damaged grassbag immediately. DO NOT operate the mower with a damaged grassbag. ALWAYS stop the engine and disconnect the spark plug lead before attempting to remove a grass blockage.**

**Grassbag removal:** Raise the rear deflector and hook the grassbag over the upper mounting points. Lower the grassbag to rest against the rear of the mower. Finally lower the rear deflector to rest against the top of the grassbag.

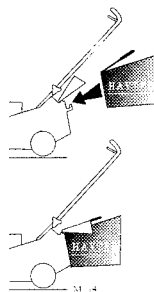

**Grassbag removal:** Raise the rear deflector and lift the grassbag away from the mower. Finally lower the rear deflector to rest against the rear of the mower.

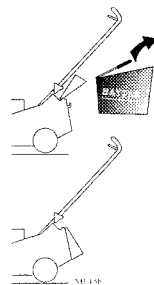

**Grassbag emptying:** To empty the grassbag, pour out the grass clippings and shake the grassbag vigorously to clean the airways. Good grass collection depends on good air flow through the grassbag. When collecting grass clippings it is important that the grassbag is emptied regularly to prevent blockages and engine overloading.

**MOWING WITHOUT GRASS COLLECTION**

To mow without collecting the grass clippings, remove the grassbag and operate the mower with the rear deflector in its lowest position.



**!** **WARNING: PREVENT ACCIDENTS - ALWAYS check the condition of the rear deflector for signs of damage. Replace a damaged rear deflector immediately. Never operate the mower with a damaged rear deflector.**

**HEAVY GROWTH**

Areas of heavy growth should be mown without grass collection. If grass collection is required, first mow the area without grass collection at the maximum height of cut setting. Allow the grass clippings to dry out and then mow the area at the maximum height of cut setting with the grassbag fitted. Reduce the height of cut and mow the area again as necessary until the required finish is obtained.

**TRANSPORTING THE MOWER**

Set the mower to its maximum height of cut to protect the cutting mechanism when transporting the mower over surfaces other than grass.

**!** **WARNING: PREVENT ACCIDENTS - Transport the mower carefully at slow walking speed with the engine switched off.**

**CUTTERBAR OPERATION**

The cutterbar rotates at the same speed as the engine. The cutterbar will stop within five seconds of the engine being switched off.

**WARNING: PREVENT ACCIDENTS - DO NOT** operate the mower if the cutterbar fails to stop within five seconds. Return the mower to an authorised Hayter dealer for examination and repair.

The cutterbar is driven by the engine via a friction device to help prevent damage occurring to the cutting mechanism when a hidden obstruction or overload is encountered. When the obstruction or overload situation is removed the friction device will automatically reset.

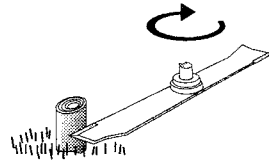

**WARNING: PREVENT ACCIDENTS - ALWAYS** stop the engine when a hidden obstruction or excessive vibration is encountered. Disconnect the spark plug lead and examine the cutting mechanism. ALWAYS replace a damaged cutterbar, refer - "Maintenance".

**MOWING AND GRASS CARE TIPS**

In dry weather conditions leave the grass long to help retain ground moisture.

Aerate the lawn to stimulate soil organisms and root growth. In spring and late summer remove dead grass and aerate the lawn by raking or using a purpose made product.

Maintain a sharp cutterbar. A blunt cutterbar will tear the grass and cause the tips to turn brown.

**MOWING AND GRASS CARE TIPS**

Continued.

Prevent scalping. Plan your direction of travel to mow across hollows and humps.

Prevent grass damage. Stop forward travel when making a turn.

Prevent grass damage. **DO NOT** mow in wet conditions.

Brush the lawn surface to disperse worm casts before mowing.

Spike compacted lawn areas with a fork. Fill the holes with sand to improve aeration and drainage.

Mow lawns in a different direction to the previous cut.

As a general rule the grass clippings should be removed each time you mow. If weather conditions are dry and hot and the grass is weed free, leave the clippings on the lawn to help maintain ground moisture.

Mow lawns twice a week when the grass is growing vigorously in the summer.

Mow lawns once a week in spring, autumn and during prolonged dry weather in the summer.

**Prevent grass damage - DO NOT remove more than one third of the grass height in one cut.**

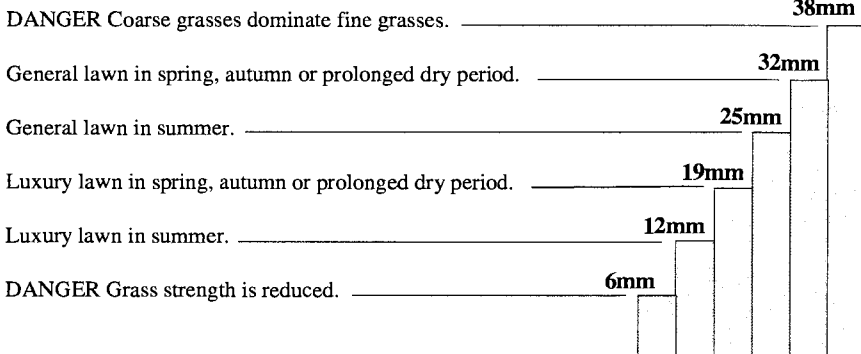
**Recommended grass heights for lawns:**

## MAINTENANCE

## ENGINE

**Engine handbook:** For details of engine maintenance refer to the engine operating and maintenance instructions handbook supplied with your mower.

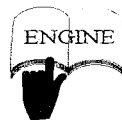

**IMPORTANT - Draining engine oil:** To drain the engine oil, first drain fuel by operating the engine until the fuel tank is empty and the engine stops. Remove the spark plug lead and allow the engine to cool. Position the mower on its left hand side and ensure that the air cleaner side of the engine is kept uppermost. Remove the oil filler-dipstick to drain the oil.

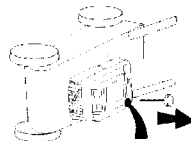

## GRASSBAG

Remove grass debris from the grassbag immediately after use and check its condition for signs of damage.

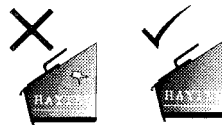

**WARNING: PREVENT ACCIDENTS -Do not use the grassbag if damaged.**

## DECK HOUSING

Remove grass debris from the deck housing and around the engine immediately after use.

**SECURING NUTS AND BOLTS**

Regularly check that all securing nuts and bolts are tight.  
Replace missing or damaged components immediately.

**LUBRICATION**

Lubricate the wheels, pivot points and linkages with engine oil every 25 operating hours.

Apply a good quality medium grease to the inner control cable at the point of entry and exit from the outer casing.





## CUTTERBAR

**! WARNING: PREVENT ACCIDENTS** -Never work on the cutterbar unless the spark plug lead has been removed. The cutterbar has sharp edges. **ALWAYS** wear strong gloves to protect your hands when working on the cutterbar. **DO NOT** operate tools towards the cutting edges to avoid the risk of injury should the tool slip. **ALWAYS** use genuine Hayter replacement parts.

The condition of the cutterbar and its mounting arrangement should be checked regularly for signs of wear or damage. Ensure that the cutterbar is not bent or cracked.

A damaged cutterbar that is out of balance will vibrate excessively and may break. **DO NOT** use an unbalanced cutterbar.

Regularly check that the bolt securing the cutterbar is tightened to the specified torque of 54Nm ( 40 lbs. ft. ).

Replace the cutterbar every 2 years or sooner if excessively worn or damaged.

**How to remove the cutterbar:** Drain the fuel by operating the engine until the fuel tank is empty and the engine stops. **Remove the spark plug lead** and allow the engine to cool. Turn the mower on its right hand side and ensure that the exhaust side of the engine is uppermost.

Firmly grip the end of the cutterbar with the gloved hand and remove the bolt, spring washer and distance piece securing the cutterbar with a 9/16" A/F spanner.

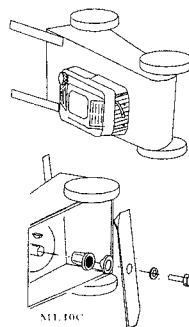

**How to assemble the cutterbar:** Assemble the cutterbar with the turned up edges facing towards the engine. Secure the cutterbar using the original bolt, spring washer and distance piece and tighten to a torque of 54Nm ( 40 lbs.ft. ).

**CUTTERBAR** Continued.

**How to sharpen and balance the cutterbar:** A slightly worn cutterbar may be re-sharpened. Both cutting edges must be sharpened equally to ensure balance. Sharpen the cutterbar every 25 mowing hours or more frequently if conditions require.

Remove the cutterbar from the mower and clean using a brush and water. Inspect the cutterbar for signs of damage.

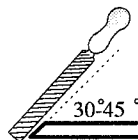

**WARNING: PREVENT ACCIDENTS - DO NOT use a damaged or excessively worn cutterbar.**

Sharpen both cutting edges with a flat file to restore the original cutting edges.

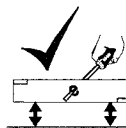

Ensure that the cutterbar is balanced. Use a screw driver with a round shaft to support the cutterbar through its centre hole. Hold the cutterbar horizontal and then release. A balanced cutterbar will remain horizontal. If the cutterbar is not balanced the heavy end will rotate downwards. Sharpen the heavy end until the cutterbar is correctly balanced.

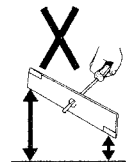

A sharp cutterbar will give optimum performance.

**PREPARING THE MOWER FOR STORAGE**

**Handlebar storage:** To lower the handlebar unscrew the 2 securing knobs sufficiently to allow it to be pivoted forwards to rest against the mower. Take care to ensure that the control cable does not become snagged at the pivot point and depress the engine stop lever to prevent it being damaged through contact with the engine.

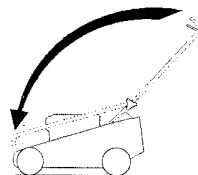

**Storage for long periods:** To ensure your mower is maintained in good working order it is important that the following procedure is adopted when the mower is stored for periods in excess of one month. Refer to the maintenance section and engine handbook as necessary.

Drain fuel from the engine by operating the engine until it stops.

Disconnect the spark plug lead. Change the engine oil.

Remove the engine spark plug and pour 15ml of engine oil into the engine cylinder and replace the spark plug. Do not exceed the stated volume of oil as engine damage may occur on re-starting. Operate the engine brake lever and slowly pull the engine start - grip once to crank the engine. This will distribute the oil and help prevent engine corrosion.

Clean all areas of the mower and ensure that the grassbag is clean.

Lubricate the mower.

Treat metal parts with a water repellent anti-corrosion product.

Lower the handlebar, if desired.

Rest the mower deck on wooden blocks to remove the weight of the mower from its wheels / roller.

Cover the mower with a protective sheet and store it in a dry, ventilated area.

**FAULT FINDING**

<b>PROBLEM</b>	<b>POSSIBLE FAULT</b>	<b>REMEDY</b>
Engine will not start.	Engine under load. Fuel starvation. Incorrect / contaminated fuel. Spark plug lead disconnected. Engine brake not released. Faulty spark plug.	Raise height of cut. Fill fuel tank. Drain fuel tank and fill with correct fuel. Connect spark plug lead. Operate engine stop lever. Clean and adjust gap or replace.
Engine runs rough.	Spark plug lead becoming disconnected in use. Faulty spark plug. Air cleaner element blocked. Incorrect / contaminated fuel.	Connect spark plug lead. Clean and adjust gap or replace. Replace air cleaner element. Drain fuel tank and fill with correct fuel.
Engine vibrates excessively.	Mounting bolts loose. Cutterbar bolt loose. Cutterbar out of balance.	Tighten bolts. Tighten bolt. Balance cutterbar.
Uneven cut.	Undulating ground contours. Cutterbar worn. Cutterbar out of balance. Wheels damaged.	Change direction of travel. Sharpen the cutterbar. Balance cutterbar. Inspect and replace as necessary.

**FAULT FINDING**

Continued.

<b>PROBLEM</b>	<b>POSSIBLE FAULT</b>	<b>REMEDY</b>
Discharge chute blocks.	Grass is wet. Cut height too low. Grassbag full. No airflow through the grassbag.	Mow dry grass. Increase cut height. Empty grassbag. Clean the grassbag.
Mower is hard to push.	Height of cut too low. Wheels damaged.	Increase height of cut. Inspect and lubricate or replace as necessary.
Poor grass collection.	No airflow through the grassbag. Discharge chute blocked. Wet grass. Grassbag full.	Clean the grassbag. Remove blockage. Mow dry grass. Empty grassbag.

## PARTS LIST

ITEM NO.	DESCRIPTION	PART NO.	QTY.
1	Deck	300123V	1
2	Key	1662	1
3	Engine - Sprint 35	308054	1
4	Drive Fastener	300144	4
5	Brake Cable	312002	1
6	M6 x 16 Pan Pozzi Taptite Screw	09596	6
7	Height Adjuster Handle	300065	1
8	Decal - Hunter 41	302027	1
9	3/8" x 1.1/4" UNC Taptite Screw	09349	3
10	Decal - Height of Cut Indicator	305113	1
11	Decal - Height of Cut	320006	1
12	Decal - Hayter / Royal Warrant	300157	1
13	Decal - Serial No.	_____	1
14	Deflector	300050	1
15	Trigger	300066	1
16	Trigger Spring	300067	1
17	Cable Tie	3966	3
18	Compensating Spring	300070	1
19	M6 Plain Washer	09472	6
20	Pillar	300137	1
21	M6 Nylon Ins 'T' Type Nut	09544	2
22	Grip-Fix	02385	2
23	Throwplate	300124	1
24	Spacer - Rear Axle	302017	1
25	M6 x 16 Pozidrive Screw	09634	4
26	Blade Adaptor	MU42734	1
27	Cutterbar	302026	1
28	Securing Plate	300039	4
29	Washer	MU17X137	1
30	3/8" x 1.1/2" UNF Hex. Hd. Bolt	09118	1
31	Connecting Rod	300104	1
32	M6 x 12 Hex. W/Hd. Screw	09546	4
33	Hub Cap	219143	4
34	1/2" Nylon Wheel Nut	4486	4
35	Wheel - 6"	302016	4
36	Front Axle Assembly	300111	1
37	Rear Axle Frame	302055W	1

## PARTS LIST

Continued.

ITEM NO.	DESCRIPTION	PART NO.	QTY.
38	Handlebar Upper	305091W	1
39	M5 x 35 Pozi-taptite Screw	09358	1
40	M8 Nylon Ins. 'T' Type Nut	09441	2
41	Decal - Caution	219189	1
42	M6 x 20 Hex. W/Hd. Screw	09575	3
43	Deflector Spring O / S	300052	1
44	Deflector Rod	300051	1
45	Deflector Spring N / S	300053	1
46	Grassbag Fabric	300147	1
47	Grassbag Frame	300045	1
48	Buffer Anti-Rattle	300110	4
49	M8 x 40 Coachbolt	09379	2
50	Grassbag Complete Assembly	300146	1
51	Rope Guide	305093	1
52	Decal - Engine Stop	331046	1
53	Guide Rope	305127	1
54	Engine Stop Lever	340179	1
55	Pin Pivot	340182	2
56	11mm Washer - Nylon	09688	6
57	6mm x 20 Screw	09687	2
58	Handlebar - Lower	300062	2
59	Knob	226013	2
60	M8 x 45 Handlebar Bolt	226024	2
61	Tube Plug	300160	2
62	M8 Nut Cap	234051	2
63	Decal - Fill Oil Here	302063	1
64	Decal - Fill Petrol Here	302064	1

