

HARRIER 41

CODE

305N . 306N
(Push) (Auto Drive)

OWNER'S HANDBOOK

CERTIFICATE OF CONFORMITY

I, the undersigned A. D. BONE, of ;

HAYTER LIMITED. Spellbrook, Bishop's Stortford,
Herts. CM23 4BU,
ENGLAND.

certify that the lawnmowers;

	CODE 305N	CODE 306N
1. Model No.	305N	306N
2. Category.	Combustion Engine	Combustion Engine
3. Make.	Hayter	Hayter
4. Type.	Rotary	Rotary
5. Engine - Manufacturer.	Briggs & Stratton	Briggs & Stratton
- Type.	09C902-0306-01	09C982-0305-01
- Speed of rotation during test.	3000 rpm	3000 rpm

Conforms to the specifications of Directive 84/538/EEC as adapted to technical progress by Directive 87/252/EEC and amended by Directive 88/180/EEC.

Guaranteed maximum sound power level.	96 dB(A)	96 dB(A)
- Type of cutting device.	Cutterbar	Cutterbar
- Width of cutting device.	41 cm	41 cm
- Speed of rotation of the cutting device.	3000 rpm	3000 rpm

TESTED AT SUDBURY,
SUFFOLK, ENGLAND.

17.03.95

17.03.95

Signed:



A.D. Bone
(Technical Manager).

EC DECLARATION OF CONFORMITY

Company Name HAYTER LIMITED.
Company Address Spellbrook Lane West
Spellbrook
Bishop's Stortford
Herts. CM23 4BU
ENGLAND.



Machine Type No. Code 305N Code 306N
Models Harrier 41 Push Harrier 41
Self Propelled

Directives complied with: 89/392/EEC amended by 91/368/EEC, 93/44/EEC and 93/68/EEC.
Essential Health & Safety Requirements Relating to the Design & Construction of
Machinery and Safety Components.
84/538/EEC amended by 87/252/EEC and 88/180/EEC Permissible Sound
Power Levels of Lawn Mowers.

Standards Used: BS5107. EN292. ISO 3767. ISO 3789. ISO 3864. ISO 4196.

I declare on behalf of Hayter Limited that these machines conform to the EC Essential Health & Safety Requirements.

Signed:



Date: 21.09.95

A.D. Bone
(Technical Manager).

Lawnmower vibration information. RMS acceleration measured in 3 - axes at operators contact position on the handlebars. Code 305N = 13.0ms^{-2} Code 306N = 13.0ms^{-2}

305125LC050995 D

INTRODUCTION

Thank you for purchasing a **Hayter** mower. The following pages are designed to help you gain safe and efficient service from your machine.

IMPORTANT : Read and understand this handbook prior to operating your machine for the first time. Make sure you are familiar with all the controls and points of regular maintenance. If you have any doubts, consult your **Hayter** authorised dealer who will be pleased to give you assistance.

All **Hayter** mowers are robustly constructed and designed for efficient economical performance under normal mowing conditions. Correct operation and maintenance will ensure a long and satisfactory service life. Prior to despatch from our factory every effort is made to ensure your machine arrives in perfect condition. Your dealer will carry out a pre-delivery inspection to ensure that there has been no transit damage prior to installation. **Please allow your dealer to familiarise you with the controls and safety features of the machine during installation.**

Throughout this handbook all references to left hand and right hand are as viewed from behind the handlebar, facing in the direction of forward travel.

This handbook is based on information available at the time of publication.

HAYTER LIMITED reserve the right to make changes at any time without notice.

LIMITED WARRANTY

Hayter Limited warrants to the original user/ purchaser that this unit shall be free from defects in material and workmanship under normal use and service for a period of one year from the date of purchase. This warranty does not cover engines, batteries (except as noted below), or wearing parts i.e. cutterbars, wheels and tyres. If you are uncertain whether your machine contains or is equipped with one or more of these parts, consult your dealer for clarification. Subject to the conditions and exclusions noted in this limited warranty, we shall at our option, repair or replace any warranted part during the applicable period.

Engine manufacturers furnish their own warranties and provide services through their authorised network. If you experience any difficulty in obtaining warranty for these items, please contact your specialist **Hayter** dealer.

This warranty which is not capable of assignment, does not apply to any unit that has been tampered with, altered, misused, abused or used for hire and will become invalid if non genuine **Hayter** parts are fitted. This warranty does not cover minor mechanical adjustments unless they are due to defective materials or workmanship. Consult the owners handbook or your authorised **Hayter** dealer for assistance when making these adjustments.

A warranty period of 90 days applies to machines used for commercial purposes.

To make a warranty claim, return the unit to the authorised **Hayter** dealer through whom the machine was originally supplied, along with proof of purchase indicating the machine serial number and purchase date. Subject to the conditions and exclusions in this limited warranty, the authorised dealer will, at our option, repair or replace any warranted part within the duration of the warranty period.

This limited warranty gives you specific legal rights and is in addition to any statutory rights to which you may be entitled and your statutory rights are not affected by this warranty. If you need additional information concerning this written warranty or assistance in obtaining services please write to:





HAYTER LIMITED, Service Department, Spellbrook, Bishop's Stortford, Herts. CM23 4BU.

SAFETY PRECAUTIONS





THIS SYMBOL MEANS BE ALERT! YOUR SAFETY IS INVOLVED. EXERCISE GREAT CARE AND FOLLOW THE ADVICE GIVEN TO AVOID POTENTIALLY HAZARDOUS SITUATIONS.

The Harrier 41 is perfectly safe if used correctly. Failure to observe the following simple precautions may result in serious injury.

Training:

-  Read the instructions carefully. Ensure that you are familiar with the controls and the proper use of the equipment. Learn how to stop the mower quickly in an emergency.
-  Never allow children or people unfamiliar with these instructions to use the mower.
-  Never mow while people, especially children, or pets are nearby.
-  Keep in mind that the user is responsible for accidents or hazards occurring to other people or their property.

Preparation:

-  While mowing, always wear substantial footwear and long trousers. Do not operate the equipment when barefoot or wearing sandals.
-  Thoroughly inspect the area where the mower is to be used and remove all stones, sticks, wires, bones and other foreign objects.
-  **WARNING:** Petrol is highly flammable.
 - Store fuel in containers specifically designed for this purpose.
 - Refuel outdoors only and do not smoke while refuelling.
 - Add fuel before starting the engine. Never remove the cap from the fuel tank or add petrol while the engine is running or when the engine is hot.
-  If petrol is spilled, do not attempt to start the engine but move the mower away from the area of spillage. Avoid creating any source of ignition until petrol vapours have dissipated.
-  Replace faulty silencers.

SAFETY PRECAUTIONS

Continued.

 Always ensure that the mower is in a safe operating condition. Frequently check all nuts, bolts and screws for tightness. Use only genuine **Hayter** replacement parts.

 Damaged cutterbars and loose fixing bolts are major hazards. Before use, visually inspect the cutting mechanism to ensure that it is in good condition. A damaged cutterbar must be replaced immediately with a genuine **Hayter** replacement part. Cutterbars which are slightly worn can be resharpened. Ensure that both cutting edges are resharpened equally to maintain balance. An unbalanced cutterbar may cause serious damage to your machine.
Refer to "Maintenance."

Operation:

 Do not operate the engine in a confined space where dangerous carbon monoxide fumes can collect.

 Mow only in daylight or good artificial light.

 Avoid using the mower on wet grass, where feasible.

 Always be sure of your footing on slopes.

 Walk, never run.

 Mow across the face of slopes, never up and down.

 Exercise extreme caution when changing direction on slopes.

 Do not mow excessively steep slopes.

 Use extreme caution when reversing or pulling the mower towards you.

 Stop the engine if the mower has to be tilted for transportation when crossing surfaces other than grass and when transporting the mower to and from the area to be mowed.

 Never operate the mower unless the guards are securely in position and in good condition.







 Do not change the engine governor settings or overspeed the engine.

 Disengage the rear roller drive clutch before starting the engine. (Self propelled model only).

SAFETY PRECAUTIONS

Continued.

Operation continued:

-  Start the engine carefully, with feet well away from the cutterbar.
-  Do not tilt the mower when starting the engine.
-  Do not put hands or feet near or under rotating parts.
-  Never pick up or carry a mower while the engine is running.
-  Stop the engine and disconnect the spark plug lead:
 - Before clearing blockages or unclogging the discharge chute.
 - Before cleaning/checking or working on the mower.
-  Stop the engine:
 - Whenever you leave the mower.
 - Before refuelling.
 - After striking a foreign object. Inspect the mower for damage and make repairs before restarting and operating the mower.
 - If the mower starts to vibrate abnormally (check immediately).
-  When using the machine without the grassbag, do not lift the deflector plate whilst the mower is in operation.









WARNING: THE CUTTERBAR CAN CONTINUE TO ROTATE AFTER THE ENGINE IS SWITCHED OFF.

SAFETY PRECAUTIONS

Continued.

Maintenance and storage:

-  Keep all nuts, bolts and screws tight to ensure that the equipment is in safe operating condition.
-  Never store the mower with petrol in the tank within an enclosed area where fumes may reach an open flame or spark.
-  Allow the engine to cool before storing in any enclosure.
-  To reduce the fire hazard, keep the engine, silencer, battery compartment and petrol storage area free of grass, leaves, or excessive grease.
-  Check the grassbag frequently for wear or deterioration.
-  Replace worn or damaged parts for safety.
-  If the fuel tank has to be drained, it is essential that this be done outdoors.

DECALS

WARNING DECAL: Part No. 219189

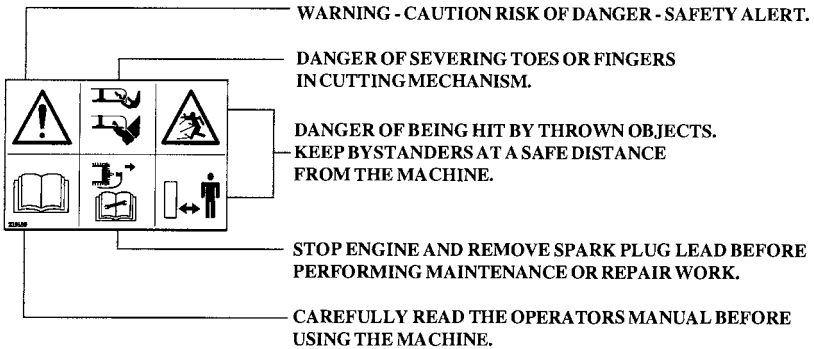

TRANSMISSION CLUTCH/ ENGINE STOP DECAL : Part No. 331047
(Codes 306N only)



ENGINE STOP DECAL Part No. 331046
(Code 305N only)



CUT HEIGHT ADJUSTMENT DECAL : Part No. 320006



DECAL - HEIGHT OF CUT INDICATOR : Part No. 305113



ENGINE SPEED DECAL :



SPECIFICATIONS

MODELS	CODE 305N Push	CODE 306N Self propelled
Engine	Briggs & Stratton Quattro 38	
Engine type	09C902-0306-01	09C982-0305-01
Engine / cutterbar speed	3000 rpm	3000 rpm
Fuel type	Unleaded petrol rated octane 77	
Fuel capacity	1.0 litres (1.8 UK pints)	
Oil type	SAE 30 engine oil	
Oil sump capacity	0.6 litres (1.1 UK pints)	
Cutting width	410mm (16 inch)	
Cutting height	12 - 65mm (0.5 - 2.6 inch)	
Overall dimensions	1,340 x 451 x 1,041mm (52.75 x 17.75 x 41 inch)	
Dry Weight	29 Kg (64 lbs)	30 Kg (66 lbs)

ASSEMBLY INSTRUCTIONS

SAFETY NOTICE



Before using the mower, read the owners handbook carefully. Pay particular attention to the safety precautions.

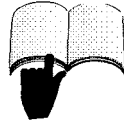

GENERAL ASSEMBLY

- 1 Handlebar.
- 2 Ground Drive Clutch Lever (306N Only).
- 3 Throttle Control.
- 4 Grassbag Assembly.
- 5 Rear Deflector.
- 6 Serial Number Decal.
- 7 Height of Cut Adjuster.
- 8 Spark Plug Lead.
- 9 Primer Bulb.
- 10 Fuel Filler Cap.
- 11 Oil Filler Cap and Dipstick.
- 12 Handlebar Securing Knob.
- 13 Rope Guide.
- 14 Engine Start-Grip.
- 15 Engine Stop lever.

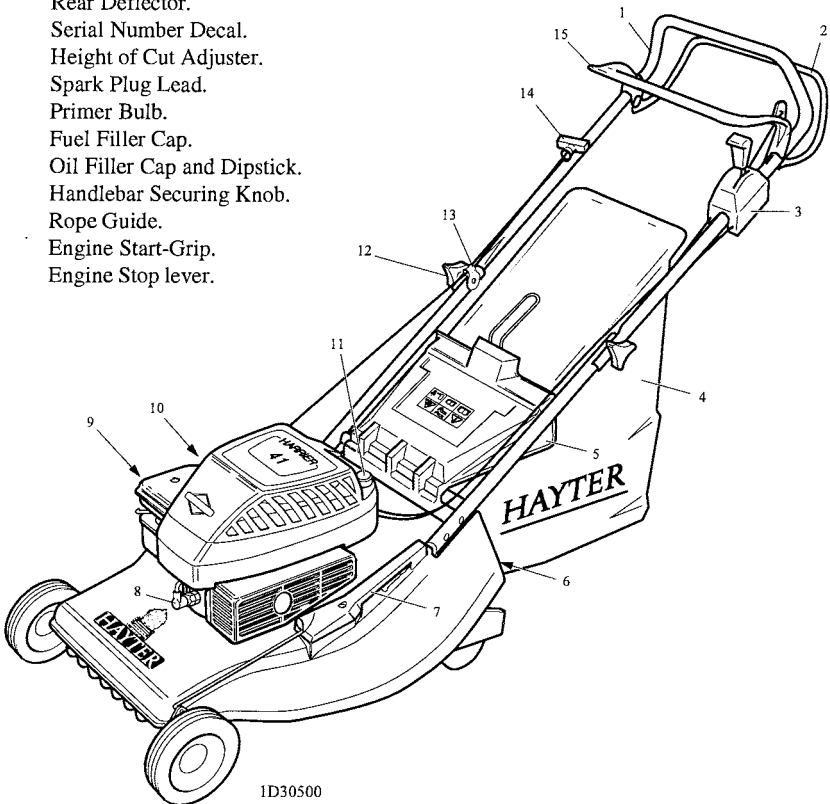

ID30500

ASSEMBLING THE MOWER FOR THE FIRST TIME

Check that parts are delivered correctly: Remove the mower from the packaging and check that all loose items have been supplied correctly. Refer to the delivery checklist opposite and the general assembly. If any items are missing, contact your local Hayter Dealer.

DELIVERY CHECKLIST

Description	Quantity
Grassbag	1
Owner's Handbook	1
Engine Handbook	1

Assemble the handlebar: Unscrew the knobs securing the handlebar sufficiently to allow it to be pivoted. Move the engine stop lever away from the engine to avoid damage and unfold the handlebar to its operating position. Tighten the two knobs to secure the handlebar, ensure that the knobs are assembled to the outside of the handlebars.

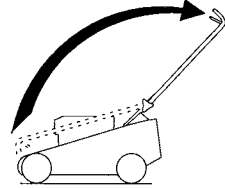

CAUTION - PREVENT DAMAGE : When unfolding the handlebar, take care to ensure that the controls and cables do not become damaged. Always replace damaged controls and cables before using the mower.

Assemble the grassbag: Identify the grassbag and remove the long ribbon label (when fitted) by cutting it off close to the grassbag. Discard the ribbon label.

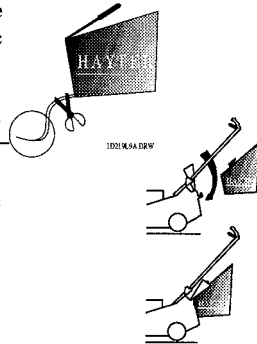

WARNING - AVOID ENTANGLEMENT : Completely remove this ribbon before using the mower.

Raise the rear deflector and lower the grassbag through the handlebar aperture to connect onto the upper mounting points. Lower the grassbag to rest against the rear of the mower. Finally lower the rear deflector to rest against the top of the grassbag.

Check that all fasteners are secure.

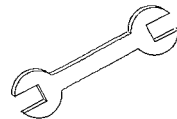

ASSEMBLING THE MOWER FOR THE FIRST TIME

Continued.

Check engine stop lever operation: Operate the engine stop lever several times. Ensure that the cable moves freely and that the lever returns automatically to the engine stop position when released.

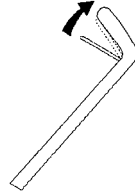

Check throttle lever operation: Operate the throttle lever several times and ensure that the cable moves freely whilst operating the engine throttle mechanism.

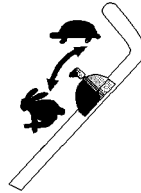

Check clutch lever operation: Operate the clutch lever several times and ensure that the cable moves freely. (Self propelled model only).



PREVENT ENGINE DAMAGE: The engine is shipped without oil or petrol. The engine must be filled with the correct grade of oil and petrol before starting the engine - refer to "Before starting the engine".

STARTING THE ENGINE

BEFORE STARTING THE ENGINE

Read the engine operating and maintenance instructions handbook supplied with this mower.

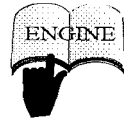

! WARNING: The cutterbar rotates when the engine is operating.

ALWAYS operate the engine stop lever several times and ensure the engine stop cable moves freely before starting the engine.

ALWAYS position the mower on a level stone free grass surface before starting the engine. Ensure that the cutterbar is set above grass height to prevent the engine being started under load.

Check oil level: With the mower on a level surface, unscrew and remove the oil filler - dipstick. Wipe oil from it with a clean cloth. Screw the oil filler - dipstick back in place, then unscrew and remove it to check the oil level.

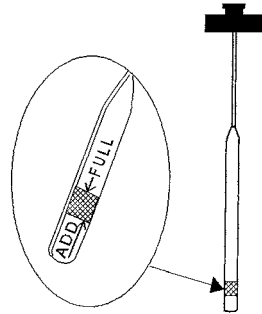

The oil level is correct when it is between the **add** and **full** marks on the dipstick.

Add SAE 30 engine oil as necessary and replace the oil filler-dipstick.

IMPORTANT: The oil filler - dipstick must be secured when the engine is running.

Check fuel level: Remove the fuel filler cap and fill the fuel tank with clean unleaded petrol rated octane 77.

Do not overfill the fuel tank. Allow 6mm minimum of tank space for fuel expansion.

IMPORTANT: The fuel filler cap must be secured when the engine is running.

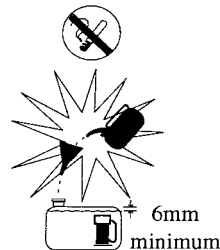

TO START THE ENGINE

Operate the throttle control lever: Push the lever to the fast position.



Operate the primer bulb: Push on the primer bulb 3 times at 2 second intervals to provide the extra fuel required to start a cold engine. Operation of the primer bulb is usually unnecessary when starting a warm engine.

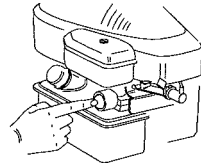

Operate the engine stop lever: Use one hand to hold the engine stop lever in the operating position firmly against the handlebar. To start and operate the engine the engine stop lever must be held in the operating position. If the engine stop lever is released the engine will stop.

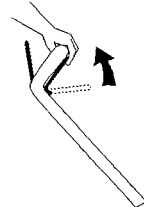

Operate the engine start - grip (Pull start models): Stand behind the mower and maintain a firm hold on the handlebar and the engine stop lever to prevent the mower moving towards you. Use your right hand to hold the engine start-grip and pull rapidly to crank the engine. When the engine starts carefully return the engine start - grip to the storage position. If the engine does not start after 5 attempts - refer to "Fault Finding".

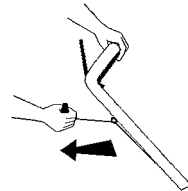

IMPORTANT: Prevent engine damage. Never pull the engine start-grip when the engine is running.

STOPPING THE ENGINE

Stopping the engine: Disengage the engine stop lever by releasing the lever.

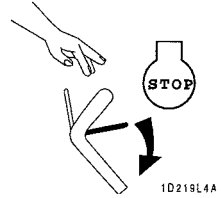

Emergency stop: If the engine stop lever fails, disconnect the spark plug lead to stop the engine.

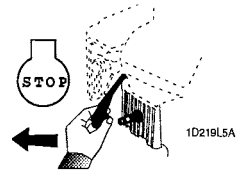

SAFETY NOTICE

WARNING: PREVENT ACCIDENTAL STARTING -
Always stop the engine and disconnect the spark plug lead before cleaning, inspecting or working on the machine.

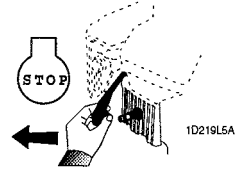

CAUTION: Before mowing, thoroughly inspect the area where the mower is to be used and remove all stones, sticks, wires, bones and other foreign objects, which when contacted by the mower cutterbar could become dangerous projectiles.

Inspect the area for hidden obstructions which when contacted by the cutterbar could risk health and safety. Remember the location of these obstructions and ensure that you mow around them.

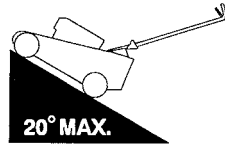

CAUTION: Prevent engine damage - DO NOT use the mower on a slope greater than 20 degrees.

**HEIGHT OF CUT**

To adjust the height of cut: Hold the trigger against the handle and raise or lower the mower using the handle to achieve the desired cut height. Release the trigger to secure the mower at the required position.

There are seven height of cut positions. The setting is indicated by the position of the connecting rod relative to the height of cut indicator.

Always select a height of cut to suit operating conditions. Aim to prevent engine overloading and blockages by avoiding low cuts in long grass conditions. Be prepared to make two cuts when the grass is long.

Self propelled model : When changing height of cut it is sometimes necessary to re-adjust the clutch cable - refer to "Maintenance; Clutch cable adjustment."

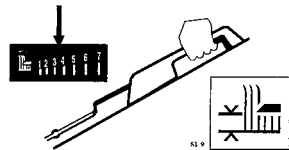

TRAVEL**Forward travel:**

Push model - Hold and push against the handlebar with both hands to move the mower forwards.



Self propelled model - Hold the handlebar and operate the clutch lever to achieve forward travel. The travel speed range can be adjusted to one of three settings to suit operator preference, refer to "Travel speed range". Travel speed is also affected by engine speed, increase engine speed to increase forward travel speed.



Release the clutch lever to stop forward travel.

When the clutch lever is disengaged the mower can be operated as a push model. This feature is useful when mowing in confined areas.

**Reverse travel:**

Push model - Hold and pull against the handlebar with both hands to reverse the mower towards you.

Self propelled model - Disengage the clutch lever. Hold and pull against the handlebar with both hands to reverse the mower towards you.



WARNING: PREVENT ACCIDENTS - Always reverse the mower carefully towards you. Always switch off the engine before walking backwards with the mower.

TRAVEL SPEED RANGE**Self Propelled Model Only**

There are 3 travel speeds ranges: fast, medium and slow. The machine is manufactured in the medium speed range, if a faster or slower speed range is required the mower should be adjusted as follows:

Raise the cut height to the highest position: Refer "Height of cut".

Remove the height adjuster handle: Remove the two screws and hold the trigger against the handle whilst carefully disconnecting the handle from the mower deck. When disconnecting the handle press down on the mower deck with one hand to assist disconnecting the handle, when the handle is removed allow the mower deck to raise slowly.

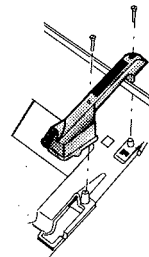

TRAVEL SPEED RANGE

(Self Propelled Model only) Continued.

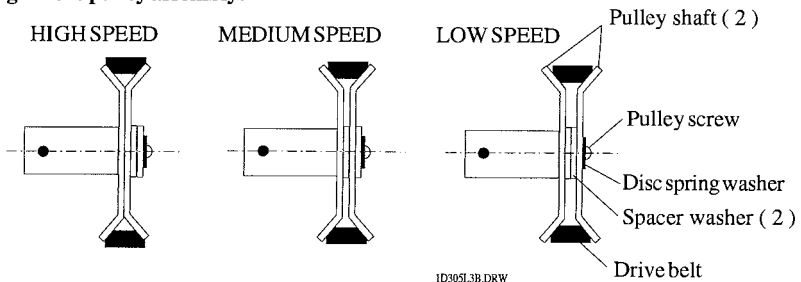
Remove the pulley screw:**Reconfigure the pulley assembly:****Secure the pulley screw:** Tighten to 9 Nm (12lb. ft) torque.

Re-assemble the height adjuster handle: Offer up the height adjuster handle assembly whilst ensuring that the trigger engages in the height adjuster mechanism correctly, press down on the mower deck to assist assembly as necessary. Tighten the two screws to secure the height adjuster handle.

Adjust cut height: Refer "Height of cut".

Adjust the clutch cable: Refer "MAINTENANCE Clutch cable adjustment".

TURNING THE MOWER

To make a wide turn : Steer the mower with the handlebar whilst travelling forward.

To make a tight turn : Stop forward travel. Apply downward pressure on the handlebar to raise the front wheels of the mower just above ground level and steer the mower using the handlebar in the required direction.



WARNING: PREVENT ACCIDENTS - DO NOT raise the front of the mower excessively when making a turn. NEVER raise the rear of the mower when the engine is running.

MOWING WITH GRASS COLLECTION

The grassbag is designed to collect grass clippings.

To achieve best grass collection performance, mow at maximum engine speed in dry operating conditions.

Recognise that when the grassbag is full the airflow stops and the grassbag deflates.

! WARNING: PREVENT ACCIDENTS - ALWAYS check the condition of the grassbag for signs of damage. Replace a damaged grassbag immediately. DO NOT operate the mower with a damaged grassbag. ALWAYS stop the engine and disconnect the spark plug lead before attempting to remove a grass blockage.

Grassbag attachment: Raise the rear deflector and connect the grassbag to the mounting points. Rest the grassbag against the rear of the mower and finally lower the rear deflector to rest and seal against the top of the grassbag.

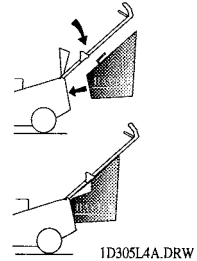

Grassbag removal: Raise the rear deflector and lift the grassbag away from the mower. Finally lower the rear deflector to rest against the rear of the mower.

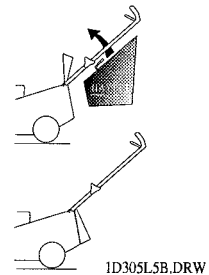

Grassbag emptying: To empty the grassbag, pour out the grass clippings and shake the grassbag vigorously to clean the airways. Good grass collection depends on good air flow through the grassbag. When collecting grass clippings it is important that the grassbag is emptied regularly to prevent blockages and engine overloading.

MOWING WITHOUT GRASS COLLECTION

To mow without collecting the grass clippings, remove the grassbag and operate the mower with the rear deflector in its lowest position.

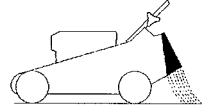

WARNING: PREVENT ACCIDENTS - ALWAYS check the condition of the rear deflector for signs of damage. Replace a damaged rear deflector immediately. Never operate the mower with a damaged rear deflector.

HEAVY GROWTH

Areas of heavy growth should be mown without grass collection. If grass collection is required first mow the area without grass collection at the maximum height of cut setting. Allow the grass clippings to dry out and then mow the area at the maximum height of cut setting with the grassbag fitted. Reduce the height of cut and mow the area again as necessary until the required finish is obtained.

TRANSPORTING THE MOWER

Set the mower to its maximum height of cut to protect the cutting mechanism when transporting the mower over surfaces other than grass.



WARNING: PREVENT ACCIDENTS - Transport the mower carefully at slow walking speed with the engine switched off.

CUTTERBAR OPERATION

The cutterbar rotates at the same speed as the engine. The cutterbar will stop within five seconds of the engine being switched off.

! **WARNING: PREVENT ACCIDENTS - DO NOT** operate the mower if the cutterbar fails to stop within five seconds. Return the mower to your Hayter dealer for examination and repair.

The cutterbar is driven by the engine via a friction device to help prevent damage occurring to the cutting mechanism when a hidden obstruction or overload is encountered. When the obstruction or overload situation is removed the friction device will automatically reset.

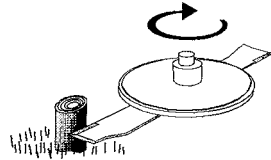

! **WARNING: PREVENT ACCIDENTS - ALWAYS** stop the engine when a hidden obstruction or excessive vibration is encountered. Disconnect the spark plug lead and examine the cutting mechanism. ALWAYS replace a damaged cutterbar - refer to "Maintenance".

MOWING AND GRASS CARE TIPS

In dry weather conditions leave the grass long to help retain ground moisture.

Aerate the lawn to stimulate soil organisms and root growth. In spring and late summer remove dead grass and aerate the lawn by raking or using a purpose made product.

Maintain a sharp cutterbar. A blunt cutterbar will tear the grass and cause the tips to turn brown.

MOWING AND GRASS CARE TIPS

Continued.

Prevent scalping. Plan your direction of travel to mow across hollows and humps.

Prevent grass damage. Stop forward travel when making a turn.

Prevent grass damage. **DO NOT** mow in wet conditions.

Brush the lawn surface to disperse worm casts before mowing.

Spike compacted lawn areas with a fork. Fill the holes with sand to improve aeration and drainage.

Mow lawns in a different direction to the previous cut.

As a general rule the grass clippings should be removed each time you mow. If weather conditions are dry and hot and the grass is weed free, leave the clippings on the lawn to help maintain ground moisture.

Mow lawns twice a week when the grass is growing vigorously in the summer.

Mow lawns once a week in spring, autumn and during prolonged dry weather in the summer.

Prevent grass damage - DO NOT remove more than one third of the grass height in one cut.

Recommended cut height:

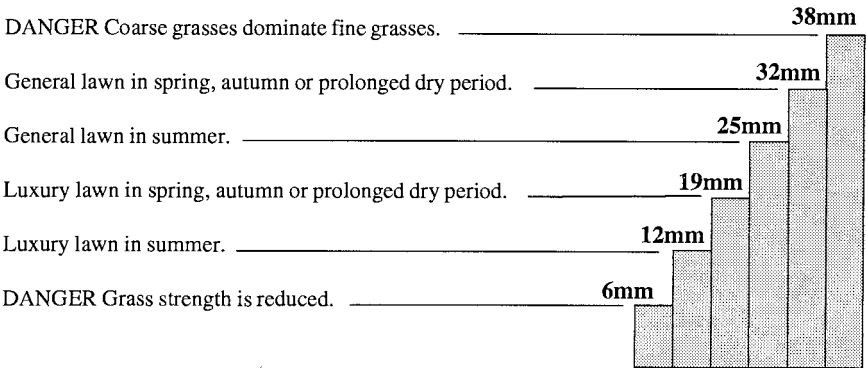

MAINTENANCE

ENGINE

Engine handbook: For details of engine maintenance refer to the engine operating and maintenance instructions handbook supplied with your mower.

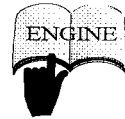

IMPORTANT - Draining engine oil: To drain the engine oil, first drain fuel by operating the engine until the fuel tank is empty and the engine stops. Remove the spark plug lead and allow the engine to cool. Position the mower on its left hand side and ensure that the air cleaner side of the engine is kept uppermost. Remove the oil filler-dipstick to drain the oil.

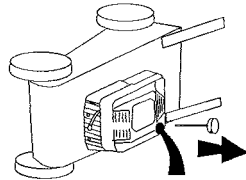

GRASSBAG

Remove grass debris from the grassbag immediately after use and check its condition for signs of damage.



DECK HOUSING

Remove grass debris from the deck housing and around the engine immediately after use.

SECURING NUTS AND BOLTS

Regularly check that all securing nuts and bolts are tight. Replace missing or damaged items immediately.

**LUBRICATION**

Lubricate the wheels, pivot points and linkages with engine oil every 25 operating hours.

Apply a good quality medium grease to the inner control cables at the point of entry and exit from their outer casings.

**CLUTCH CABLE ADJUSTMENT**

Self propelled model only.

Check the clutch cable operation every 25 operating hours and adjust if necessary. The clutch cable is adjusted correctly when the belt drive just engages with the clutch lever positioned - 32-38mm (1.1/4"-1.1/2") from the handlebar.

Unscrew the locknut and screw the adjuster as necessary, if there is insufficient thread adjustment the bracket position should be altered by removing the retaining screw and re-assembling the bracket to the handlebar using an alternative mounting hole. Tighten the locknut when correctly adjusted.

IMPORTANT: Prevent damage - ALWAYS operate the mower with the clutch cable correctly adjusted. ALWAYS replace damaged cables.

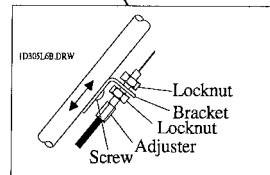
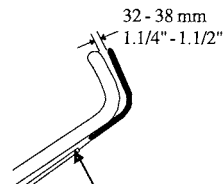

CUTTERBAR

Continued.

How to sharpen and balance the cutterbar: A slightly worn cutterbar may be re-sharpened. All cutting edges must be sharpened equally to ensure balance. Sharpen the cutterbar every 25 mowing hours or more frequently if conditions require.

Remove the cutterbar from the mower and clean using a brush and water. Inspect the cutterbar for signs of damage.

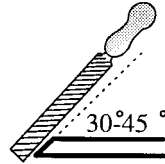

! **DO NOT** use a damaged or excessively worn cutterbar.

Sharpen all the cutting edges with a flat file to restore the original cutting edge.

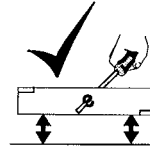

Ensure that the cutterbar is balanced. Use a screw driver with a round shaft to support the cutterbar through its centre hole. Hold the cutterbar horizontal and then release. A balanced cutterbar will remain horizontal. If the cutterbar is not balanced the heavy end will rotate downwards. Sharpen the heavy end until the cutterbar is correctly balanced.

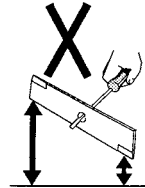

PREPARING THE MOWER FOR STORAGE

Handlebar storage: To lower the handlebar unscrew the 2 securing knobs sufficiently to allow it to be pivoted forwards to rest against the mower. Take care to ensure that the control cables do not become snagged at the pivot point and depress the engine stop lever to prevent it being damaged through contact with the engine.

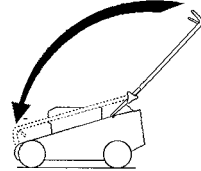

Storage for long periods: To ensure your mower is maintained in good working order it is important that the following procedure is adopted when the mower is stored for periods in excess of one month. Refer to the maintenance section and engine handbook as necessary.

Drain fuel from the engine by operating the engine until it stops.

Disconnect the spark plug lead. Change the engine oil.

Remove the engine spark plug and pour 15ml of engine oil into the engine cylinder and replace the spark plug. Do not exceed the stated volume of oil as engine damage may occur on re-starting. Operate the engine brake lever and slowly pull the engine start - grip once to crank the engine. This will distribute the oil and help prevent engine corrosion.

Clean all areas of the mower and ensure that the grassbag is clean.

Lubricate the mower.

Treat metal parts with a water repellent anti-corrosion product.

Lower the handlebar, if desired.

Rest the mower deck on wooden blocks to remove the weight of the mower from its wheels / roller.

Cover the mower with a protective sheet and store it in a dry, ventilated area.

FAULT FINDING

PROBLEM	POSSIBLE FAULT	REMEDY
Engine will not start.	Fuel starvation. Incorrect / contaminated fuel. Spark plug lead disconnected. Throttle setting incorrect. Engine brake not released. Faulty spark plug.	Fill fuel tank. Drain fuel tank and fill with correct fuel. Connect spark plug lead. Set throttle to fast position. Operate engine stop lever. Clean and adjust gap or replace.
Engine runs rough.	Spark plug lead becoming disconnected in use. Faulty spark plug. Air cleaner element blocked. Incorrect / contaminated fuel.	Connect spark plug lead. Clean and adjust gap or replace. Replace air cleaner element. Drain fuel tank and fill with correct fuel.
Engine vibrates excessively.	Mounting bolts loose. Cutterbar bolt loose. Cutterbar out of balance.	Tighten bolts. Tighten bolt. Balance cutterbar.

195

FAULT FINDING

Continued.

PROBLEM	POSSIBLE FAULT	REMEDY
Uneven cut.	Undulating ground contours. Cutterbar worn. Cutterbar out of balance. Wheels / Roller damaged.	Change direction of travel. Sharpen the cutterbar. Balance cutterbar. Inspect and replace as necessary.
Discharge chute blocks.	Grass is wet. Cut height too low. Grassbag full. Slow engine speed. No airflow through the grassbag.	Mow dry grass. Increase cut height. Empty grassbag. Increase engine speed. Clean the grassbag.
Mower is hard to push.	Cut height too low. Wheels / Roller damaged.	Increase cut height. Inspect and lubricate or replace as necessary.
Mower will not self propel. (Self propelled model only).	Clutch out of adjustment. Drive belt damaged.	Adjust clutch lever. Replace drive belt.
Poor grass collection.	No airflow through the grassbag. Discharge chute blocked. Slow engine speed. Wet grass. Grassbag full.	Clean the grassbag. Remove blockage. Increase engine speed. Mow dry grass. Empty grassbag.

PARTS LIST

ITEM NO.	DESCRIPTION	PART NO.	QTY.	
			305N	306N
1	Deck	305101V	1	1
2	Key	1662	1	1
3	Engine - Compliance	305123	1	0
	Engine - Compliance	306116	0	1
4	Spacer Washer	ZWQ1L000U	0	2
5	Pulley Half	306104	0	2
6	M6 x 16 Pan. Pozi Taptite Screw	09596	6	6
7	Height Adjuster Handle	305112	1	1
8	Decal (Engine Code 305N)	305126	1	0
	Decal (Engine Code 306N)	306117	0	1
9	3/8" x 1.1/4" UNC Taptite Screw	09349	3	3
10	Decal (Height of Cut)	305113	1	1
11	Disc Spring Washer	306110	0	1
12	Decal (Hayter / Royal Warrant)	300157	1	1
13	Decal (Serial No.)	_____	1	1
14	Spring	301031	0	1
15	Trigger	300066	1	1
16	Trigger Spring	300067	1	1
17	Axle Bolt	308021	1	1
18	Compensating Spring	300070	1	1
19	M6 Plain Washer	09472	6	7
20	Pillar	300137	1	1
21	M6 Nylon Ins 'T' Type Nut	09544	2	2
22	Rear Roller	201007	2	0
	Rear Roller	239065	0	1
23	Throwplate	300124	1	1
24	Shaft Drive	306103	0	1
25	Belt - V	306050	0	1
26	Driven Pulley	306102	0	1
27	No 10 x 1/2" Self Tap Screw	09706	0	4
28	Rope Guide	305127	1	1
29	3/8" Plain Washer (Axle Spacers)	09271	As required	
30	3/8" UNF Nylon Ins. 'T' Type Nut	09216	1	1
31	1/4" Plain Washer	09262	2	2
32	Axle Support	305040	1	1
33	Compensating Pulley	301020	0	1
34	Compensating Plate	301050	0	1
35	Grip-Fix	02385	2	3
36	Grip-Fix	04020	0	2

PARTS LIST

Continued.

ITEM NO.	DESCRIPTION	PART NO.	QTY.	
			305N	306N
37	Bearing Half	301030	0	1
38	Jockey Arm Assembly	301015	0	1
39	Pulley Tensioner	239021	0	1
40	M6 x 16 Pozidrive Screw	09634	2	3
41	Friction Disc	219203	1	1
42	Cutterbar	201026	1	1
43	Spacer	4014	1	1
44	Securing Plate	219037	3	3
45	3/8" Spring Washer	09273	1	1
46	3/8" x 1.1/2" UNF Hex Hd Bolt	09118	1	1
47	Connecting Rod	305109	1	1
48	M6 x 12 Hex W/Hd Screw	09546	4	4
49	Hub Cap	300155	2	2
50	1/2" Nyloc Wheel Nut	4486	2	2
51	6" Wheel (includes item 92)	300153	2	2
52	Front Axle Assembly	300111	1	1
53	Rear Roller Frame	306115W	0	1
	Rear Roller Frame	308050W	1	0
54	Roll Pin	03997	0	1
55	Clutch Lever	306094W	0	1
56	Handlebar Upper	305091W	1	1
57	Engine Stop Lever	340179	1	1
58	Pivot pin	340182	2	2
59	11mm Nylon Washer	09688	6	2
60	6mm x 20 Screw	09687	2	2
61	Drive Fastener	300144	2	2
62	Clutch Cable	306107	0	1
63	Bracket Clutch Cable	306108	0	1
64	Ferrule	305115	2	2
65	Bearing 1/2" Ball (suits item 51)	300154	4	4
66	Throttle Control	305124	1	1
67	No. 8 x 1.1/4" Pozi-pan Screw	09600	2	2
68	Cable Tie	3966	3	3
69	Rope Guide	305093	1	1
70	Tube Plug	300160	2	2
71	M8 x 45 Saddle Hd Bolt	226024	2	2
72	Knob	226013	2	2
73	M8 Nut Cap	234051	2	2
74	M8 Nylon Ins. 'T' Type Nut	09441	2	2
75	Handlebar Lower	300062	2	2
76	Deflector	305102	1	1

PARTS LIST

Continued.

ITEM NO.	DESCRIPTION.	PART NO.	QTY.	
			305N	306N
77	Decal (Caution)	219189	1	1 ✓
78	M6 x 20 Hex Washer Hd Screw	09575	3	3 ✓
79	Deflector Spring O/S	305111	1	1 ✓
80	Deflector Rod	305103	1	1 ✓
81	Deflector Spring N/S	305110	1	1 ✓
82	Grassbag	305104	1	1 ✓
83	Grassbag Frame	305105W	1	1 ✓
84	M6 x 16 Hex. Washer Hd. Screw	09365	2	2 ✓
85	Sealing Strip	305119	1	1 ✓
86	Screw	ZHS1H016U	0	1 ✓
87	Decal (Engine Stop)	331046	1	0 ✓
	Decal (Clutch Transmission)	331047	0	1 ✓
88	Axle Bush	305108	2	2 ✓
89	Grassbag Complete Assembly	305118	1	1 ✓
90	M8 x 40 Coachbolt	09379	2	2 ✓
91	Decal (Height of Cut)	320006	1	1 ✓

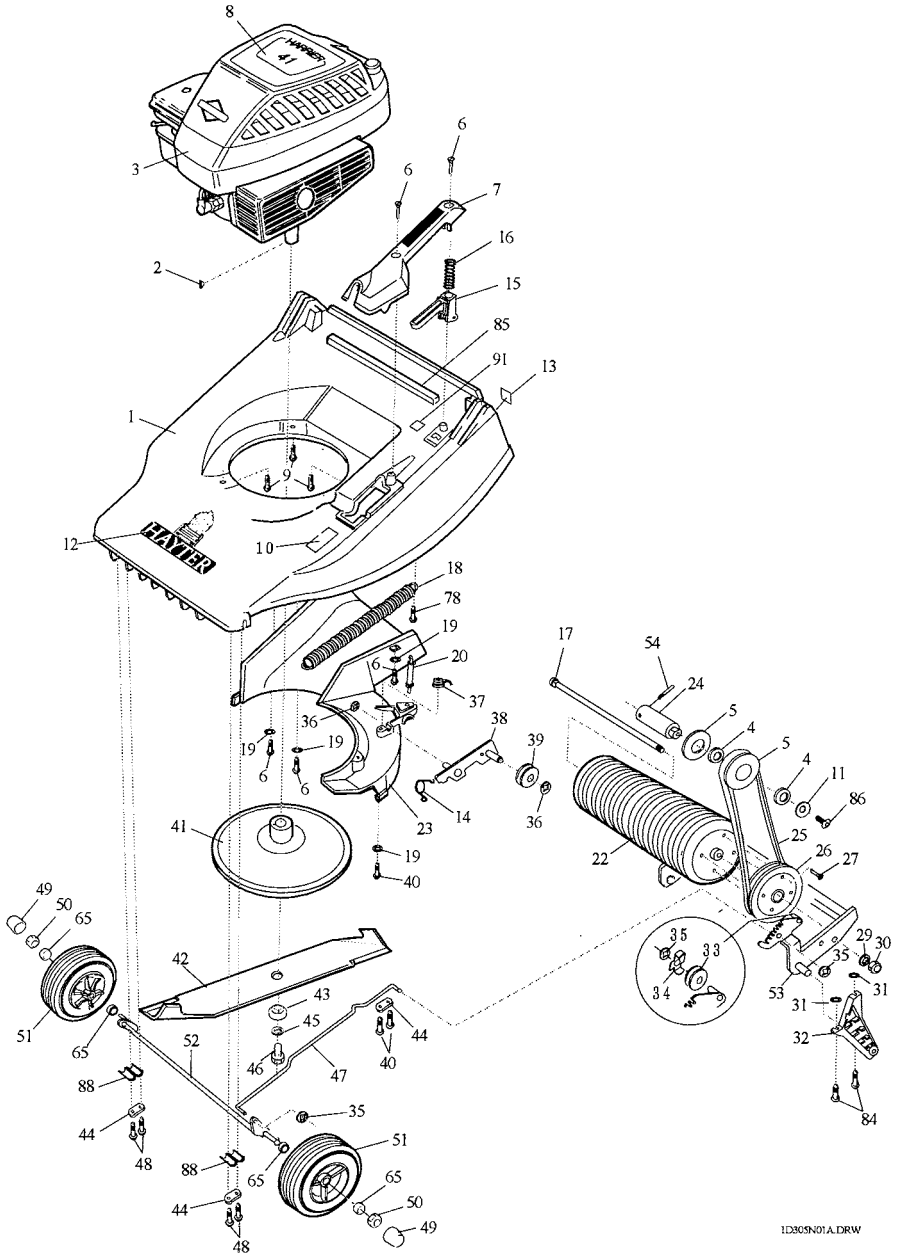

1D305N01A.DRW

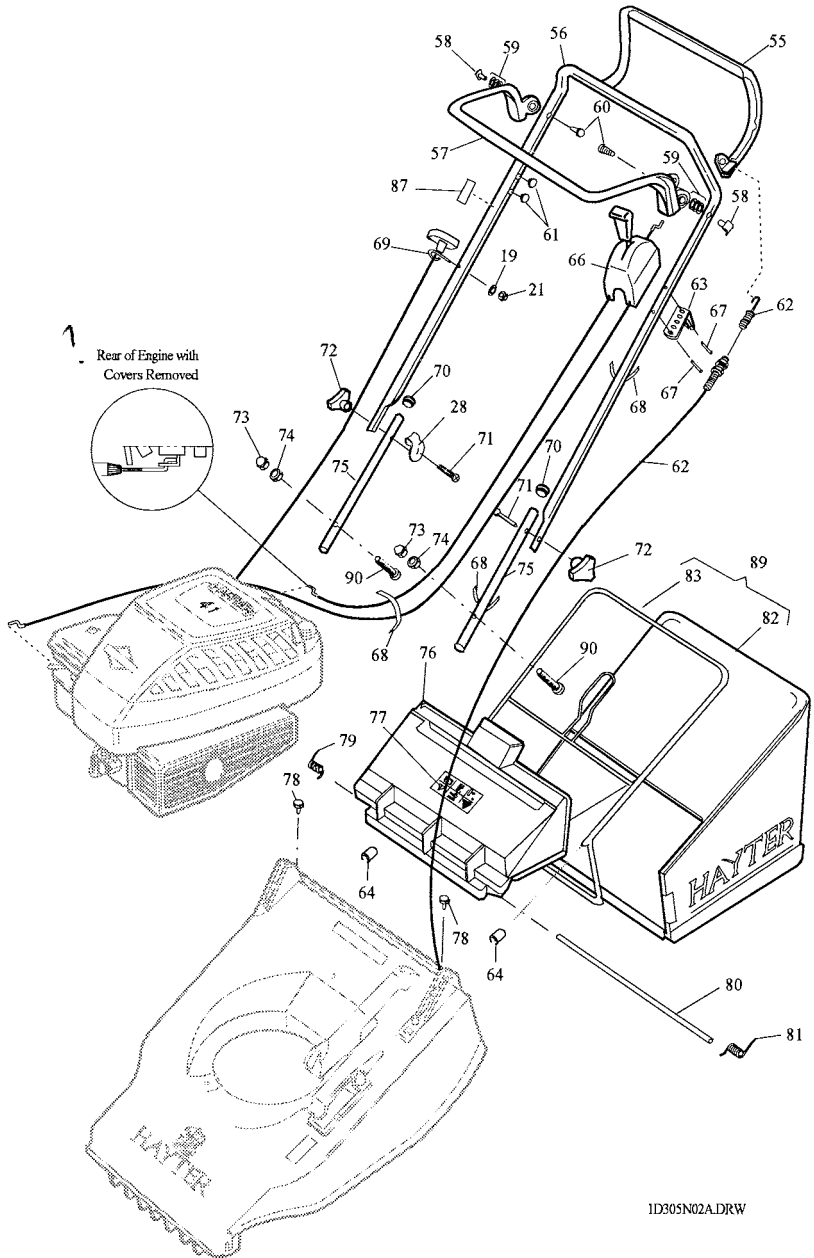

1D305N02A.DRW