



BY APPOINTMENT TO
H.M. THE QUEEN
MANUFACTURERS OF
AGRICULTURAL MACHINERY
HAYTERS PLC.

HAYTER

HOBBY 41

ROTARY LAWNMOWER

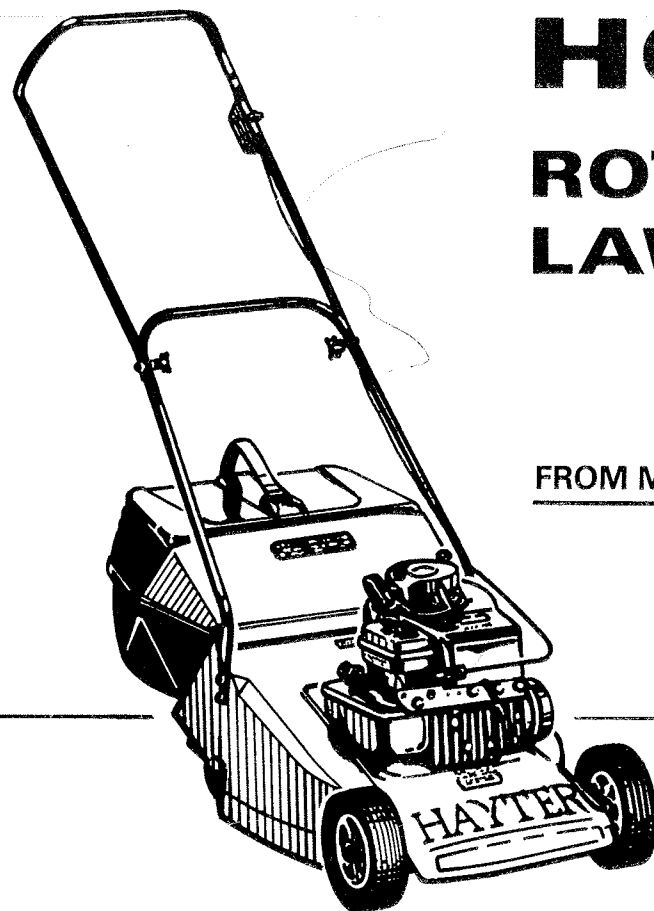

FROM MACHINE NUMBER 20187351 (RECOIL)

23411682 (E/S)



















OPERATING INSTRUCTIONS ILLUSTRATED PARTS LIST

HAYTERS PLC. SPELLBROOK BISHOP'S STORTFORD
HERTS ENGLAND CM23 4BU



SAFETY PRECAUTIONS (As recommended in B.S.5107:1974)



-  Know your controls. Read the owner's manual carefully. Learn how to stop the engine quickly in any emergency.
-  Make sure the lawn is clear of sticks, stones, bones, wire and debris. They could be thrown by the blade.
-  Stop the engine and disconnect spark plug wire before checking or working on the mower.
-  Damaged cutterbars and loose fixing bolts are major hazards. Before using, always visually inspect the cutting mechanism to ensure that it is in good condition. A damaged cutterbar should be replaced immediately, using only Hayter replacement cutterbars. Cutterbars can be re-sharpened, ensure that both cutting edges are evenly sharpened to maintain the balance.
-  Always be sure the mower is in safe operating condition. Check all nuts, bolts and screws often. Use only replacement parts made and guaranteed by HAYTERS P.L.C
-  Add fuel BEFORE starting the engine. Avoid spilling petrol and do not fill the tank while the engine is running or while you are smoking.
-  Do not mow whilst people, especially children, or pets are in the mowing area.
-  Never use the mower unless the guards provided by the Manufacturers are in position.
-  Do not mow barefoot or in open sandals.
-  Start the engine carefully with feet well away from the blades. Do not operate the engine in a confined space where exhaust fumes (carbon monoxide) can collect.
-  Stop the engine whenever you leave the mower.
-  Do not allow children or people unfamiliar with these instructions to use the mower.
-  On slopes or wet grass, be extra careful of your footing.
-  Never cut grass by pulling the mower towards you.
-  Do not overspeed the engine or alter governor settings. Excessive speed is dangerous and shortens mower life.
-  Store fuel in a cool place in a container specifically designed for the purpose. In general, plastic containers are unsuitable.
-  Warning : Blades continue to rotate after machine is switched off.
-  When using the machine without the grassbox, do not lift the deflector plate whilst the machine is in operation.
-  Never insert hand into grass discharge chute whilst the engine is running.
-  Stop the engine before pushing the mower across gravel drives, walks or roads.
-  Never pick up or carry a mower when it is operating.



THIS SYMBOL WARNS OF POTENTIALLY HAZARDOUS SITUATIONS WHICH COULD OCCUR IF GREAT CARE IS NOT TAKEN WHEN USING OR MAINTAINING YOUR MACHINE.

HOBBY 41 OPERATING INSTRUCTIONS

INTRODUCTION

The Hayter 'Hobby' 41 is designed and constructed to give an efficient and economical performance combined with ease of operation and maintenance. The correct operation and attention to routine maintenance as recommended will ensure long and efficient service from the machine.

The machine is carefully checked prior to being packed and every effort is made by Hayters to see that the machine arrives in perfect condition.

GUARANTEE

The machine is guaranteed against faulty workmanship and materials for a period of 12 months from the date of purchase. In the case of components not manufactured by HAYTERS P.L.C. no guarantee is given but the purchaser shall be entitled to any guarantee given by the manufacturers of such components. Any claim under guarantee should be referred to the Agent through whom the machine was originally supplied, quoting the machine Serial Number which is located on top of the mainframe casting at the rear of the machine.

The guarantee becomes void if any parts not made or supplied by Hayters are fitted to the machine. In the case of machines being used for hiring out purposes no guarantee of any kind is given or is to be implied.

ASSEMBLY INSTRUCTIONS

Unpack the machine from the carton and assemble the handlebars to the mainframe as outlined in the assembly instruction sheet.

OPERATING INSTRUCTIONS

Before using the machine, READ the operating instructions carefully, paying particular attention to the recommended SAFETY PRECAUTIONS. Read also the Engine Manufacturers leaflet and carry out the recommended lubrication.

To Fit the Grassbox: Raise the grass deflector and fit the grassbox over the ridge on the mainframe casing.

Cutting Height Adjustment: The cutting height range is from 1/4" to 1 3/4". To increase the height of cut, turn adjusting screw in a clockwise direction.

Engine: When starting the engine set the throttle control, which is situated on the handlebars, into the fast position. The engine is governed to run at a maximum speed of 3,400 r.p.m., should any adjustment be made to the engine it is important that the maximum speed is strictly adhered to.

HINTS ON OPERATION

Although primarily designed for lawn mowing, the Hayter 'Hobby' will deal with a variety of other grass cutting chores on reasonably flat areas. Observance of the following 'Hints' will ensure satisfactory results and eliminate undue stress being imposed on the machine.

Lawns: Fit the grassbox, set the cutting height to maximum and cut the lawn area. This will assist to predetermine the most suitable cutting height setting for the second cut and also eliminate the possibility of 'scalping' occurring on any high spots in the lawn. Thereafter, regular mowing can be undertaken at the predetermined cutting height setting.

Runaway Growth on Lawns: Set the cutting height to the highest position, remove grassbox and cut the lawn area. The cuttings can then be collected by fitting the grassbox and working over the area a second time. If cuttings are wet, leave to dry and collect later. When the machine is used without the grassbox, the deflector will cover the discharge aperture and deflect cuttings downwards and away from the operator.

Borders, Walls and Fences: The machine will cut over lawn edges and can be used to cut close up to walls, fences and other obstructions.

Hidden Obstructions: Should an obstruction be encountered whilst mowing, the machine should be drawn backwards without raising the front. The engine stopped and the plug lead removed. Examine the cutting mechanism and should the cutterbar be broken or damaged it should be replaced before further cutting is undertaken (See also maintenance instruction, under 'Cutterbar').

Blockages: A blockage in the discharge chute is usually caused by attempting to remove too much grass initially, especially when the machine is in a low cutting height setting or when conditions are wet. Allowing the grassbox to become overfull is another likely cause. Before clearing a blockage, stop the engine and remove the plug lead, NEVER insert the hand into the discharge chute whilst the engine is running.

MAINTENANCE

Lubrication

Engine: See Engine Manufacturers Leaflet.

Machine: A light application of lubricating oil to all linkages and hinge points, periodically.

Throttle Control Cable: Run-in a little lubricating oil into the inner cable from the control end.

Adjustments

Securing Nuts and Bolts: Check all securing nuts and bolts periodically and tighten if necessary.

Cutterbar: The Hayter cutterbar is friction driven by the bottom plate when in use. In the event of the cutterbar striking an obstruction it will move relative to the bottom plate to a new position at which it will continue to cut. Regular inspection of the cutting mechanism is recommended to ensure that the cutterbar is in good condition. Should the cutterbar be damaged to the extent that it is likely to become out of balance it should be replaced immediately. Fit the new cutterbar as shown in Fig. 1 ensuring that the retaining setscrew, Item No. 10 is tightened securely (For the technically minded, a torque setting of 40 ft/lb is recommended). The cutterbar may be resharpened providing that both ends are evenly sharpened to maintain the balance.

Before examining, cleaning or making any adjustment to the cutting mechanism the engine MUST be stopped and the plug lead disconnected.

CLEANING

A little time spent cleaning the machine after use will maintain both appearance and proficiency. Particular attention should be given to the underside of the mower to remove any debris which has built up on the casing. The interior of the grassbox and the air vents should be kept clean and compacted debris removed from tyre treads and rear roller grooves.



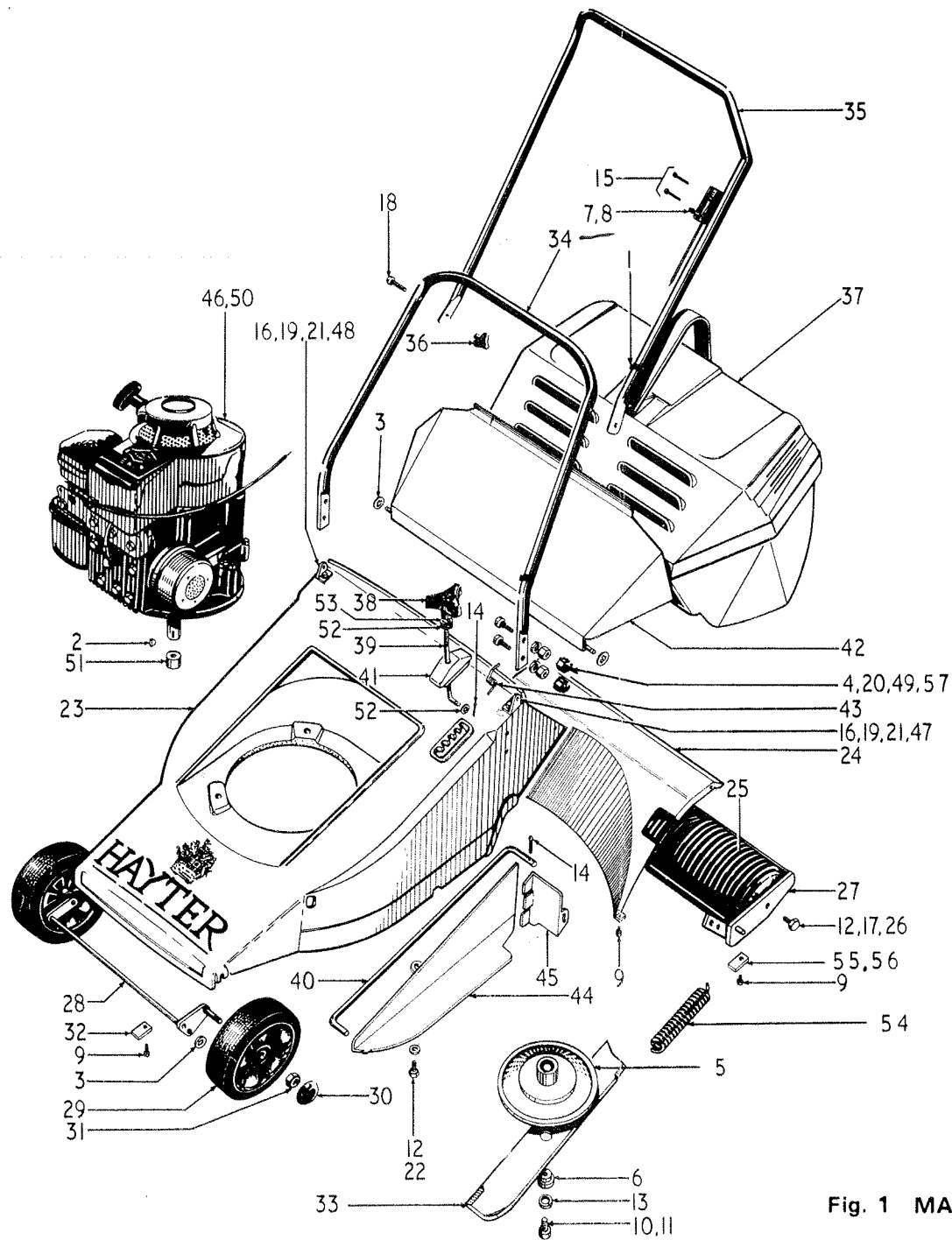

Fig. 1 MAINFRAME ASSEMBLY

SPARE PARTS LIST
(Subject to revision without notice)

FROM MACHINE NUMBER 20187351

All spares must be ordered through an authorised Hayter Agent.

When ordering spares please quote the SERIAL NUMBER of your machine and the PART NUMBER, not the ITEM NUMBER, of the required part.

ITEM NO.	PART NO.	NO OFF	DESCRIPTION	ITEM NO.	PART NO.	NO OFF	DESCRIPTION
1	363	2	Cable Tie	41	201082	1	Block
2	1662	1	Woodruff Key	42	234054	1	Deflector Assy.
3	02385	3	1/4" Spring Retainer	43	201048	2	Spring
4	03469	4	8mm Spring Washer S/C	44	234058	1	Underguard
5	4012	1	Friction Disc Assy.	45	234060	1	Guard Cover
6	4014	1	Cutterbar Distance Piece	46	201052	1	Engine Briggs & Stratton 92502-5105-1
7	217005	1	Throttle Control & Cable (Tecumseh)	47	201053	1	Hinge Bracket N/S
8	201065	1	Throttle Control & Cable (Briggs & Stratton)	48	201054	1	Hinge Bracket O/S
9	9026	6	No. 8 x 1/2" Hex. Hd. Screw	49	201060	4	M8 x 18 mm Serrated Screw
10	09118	1	3/8" UNF x 1 1/2" Bolt (Briggs & Stratton)	50	217002	1	Engine Tecumseh LAV 153
11	09121	1	3/8" UNF x 2" Hex. Hd. Bolt (Tecumseh)	51	217003	1	Spacer for Tecumseh Engine
12	09271	6	3/8" Washer	52	09266	2	Plain Washer
13	09273	1	3/8" Spring Washer S/C	53	04415	1	Spring Washer D/C
14	09303	2	Split Pin	54	201042	1	Compensator Spring
15	09358	2	M5 x 30 mm Screw Taptite Pan. Hd.	55	201105	1	Retainer N/S
16	09360	2	M5 x 12 mm Bolt	56	201106	1	Retainer O/S
17	09362	2	M6 x 16 mm Setscrew	57	234051	4	Nut Cap
18	09367	2	M6 x 40 mm Coach Bolt				
19	09430	2	M5 Selflock Nut		9319		Pop Rivet
20	09443	4	M8 Plain Nut				
21	09470	2	M5 Washer				
22	9520	3	3/8" UNC x 1" Taptite Screw				
23	201003	1	Mainframe				
24	234057	1	Throw Plate				
25	201007	2	Rear Roller				
26	201008	1	Rear Roller Shaft				
27	201009	1	Rear Roller Frame Assy.				
28	201101	1	Front Axle Assy.				
29	201095	2	6" x 1 1/4" Wheel				
30	201091	2	Wheel Cap				
31	09232	2	1/2" UNF Nylon Nut				
32	201025	2	Axle Retainer				
33	201026	1	Cutterbar				
34	201028	1	Lower Handlebar				
35	201029	1	Upper Handlebar				
36	201089	2	Knob				
37	234055	1	Grassbox Assy.				
38	201087	1	Height Adj. Knob				
39	208081	1	Adjuster Screw				
40	201041	1	Connecting Rod				

WARNING NOTICE

(Issued in accordance with Asbestos Products (Safety) Regulations 1986)
Certain components on this Mower, such as brake and clutch linings and some gaskets and joints, may contain a small quantity of asbestos.

When repairing and replacing these items care should be taken to:-

- 1) Carry out the repairs in a well ventilated area.
- 2) Remove dust by dampening down using a recommended liquid or water.
- 3) Dampen dust and place it in a properly closed receptacle.
- 4) Dispose of the receptacle safely.

If you are uncertain seek advice from your dealer.

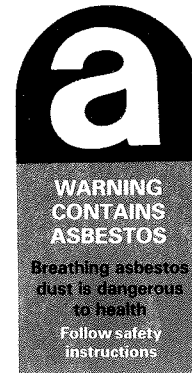

PART NO. 201057